



# EM500-PT100 User Guide



## Safety Precautions

Ursalink will not shoulder responsibility for any loss or damage resulting from not following the instructions of this operating guide.

- ❖ The device must not be remodeled in any way.
- ❖ Please clarify your application environment before deployment, in case the device can function well.
- ❖ The device is not intended to be used as a reference sensor, and Ursalink will not should responsibility for any damage which may result from inaccurate readings.
- ❖ Do not place the device cable close to objects with naked flames.
- ❖ Do not place the device, cable and probe where the temperature is below/above the operating range.
- ❖ Make sure electronic components do not drop out of the enclosure while opening.
- ❖ When closing the lid, make sure the lid is fitted the right way, so that the enclosure is properly sealed.
- ❖ When installing the battery, please install it accurately, and do not install the reverse or wrong model.
- ❖ The device must never be subjected to shocks or impacts.

## Declaration of Conformity

Ursalink EM500-PT100 is in conformity with the essential requirements and other relevant provisions of the CE, FCC, and RoHS.



© 2017-2020 Xiamen Ursalink Technology Co., Ltd.

**All rights reserved.**

All information in this guide is protected by copyright law. Whereby, no organization or individual shall copy or reproduce the whole or part of this user guide by any means without written authorization from Xiamen Ursalink Technology Co., Ltd.



For assistance, please contact  
Ursalink technical support:  
Email: [helpdesk@ursalink.com](mailto:helpdesk@ursalink.com)  
Tel: 86-592-5023060  
Fax: 86-592-5023065

## Revision History

Date	Doc Version	Description
April 7, 2020	V 1.0	Initial version

# Contents

1. Overview.....	4
1.1 Description.....	4
1.2 Features.....	4
1.3 Specifications.....	4
1.4 Dimensions(mm).....	5
2. Hardware Introduction.....	5
2.1 Packing List.....	5
2.2 Product Overview.....	6
3. Sensor Connection with EM500.....	6
4. Sensor Installation.....	7
4.1 Wall Mounting.....	7
4.2 Pole Mounting.....	8
4.3 DIN Rail Mounting.....	8
5. Turn ON/OFF the Sensor.....	8
5.1 Turn ON/OFF via Smartphone APP.....	8
5.2 Turn ON/OFF via PC Software.....	10
5.3 Turn ON/OFF via Button.....	11
6. Sensor Configuration.....	11
6.1 Configuration via Smartphone APP.....	11
6.1.1 Read Configuration.....	12
6.1.2 Write Configuration.....	12
6.1.3 Template Settings.....	13
6.2 Configuration via PC.....	15
6.2.1 Read Configuration.....	15
6.2.2 Write Configuration.....	15
6.2.3 Upgrade.....	16
6.2.4 Template and Reset.....	17
6. Sensor Parameters (for App and PC).....	18
7.1 LoRa WAN Settings.....	18
7.1.1 Basic Settings-OTAA.....	18
7.1.2 Basic Settings-ABP.....	19
7.1.3 Channel Settings.....	21
7.2 Device Settings.....	22
7.2.1 General.....	22
7.2.2 Data Calibration.....	23
7.2.3 Threshold.....	23
8.Sensor Management via Ursalink Cloud.....	24
8.1 Ursalink Cloud Registration.....	24
8.2 Add a Ursalink LoRaWAN Gateway.....	24
8.3 Add EM500-PT100 to Cloud.....	25

## 1. Overview

### 1.1 Description

EM500-PT100 is an outdoor environment monitoring sensor mainly used to collect temperature data through wireless LoRa network. EM500-PT100 device is battery powered and designed for multiple mounting ways. It is equipped with NFC (Near Field Communication) and can easily be configured by a smartphone or a PC software.

Sensor data are transmitted in real-time using standard LoRaWAN protocol. LoRaWAN enables encrypted radio transmissions over long distance while consuming very little power. The user can obtain sensor data and view the trend of data change through Ursalink Cloud or through the user's own Network Server.

### 1.2 Features

- Large measurement range of multiple temperature detection applications
- Up to 11km communication range
- Easy configuration via NFC
- Standard LoRaWAN support
- Ursalink Cloud compliant
- Low power consumption with 19000mAh replaceable battery

### 1.3 Specifications

LoRaWAN	
Frequency	EU433/CN470/IN865/RU864/EU868/US915/AU915/KR920/AS923
Tx Power	20dBm
Sensitivity	-147dBm @300bps
Mode	OTAA/ABP Class A
Antenna	Embedded Ceramic Antenna
Temperature Measurement	
Range	EM500-PT100-T200: -50°C to + 200°C EM500-PT100-T500: -50°C to + 500°C EM500-PT100-T800: -50°C to + 800°C (Customizable from -200°C to + 800°C)
Accuracy	± 0.5°C
RTD Type	3-wire
Physical Characteristics	
Probe Length	1.5m (Customize)

Probe Type	Straight tube (By default)
Power Supply	19000 mAh Li-SoCl <sub>2</sub> battery
Battery Life	6 year (10 min interval, SF12) >10 year (10 min interval, SF7)
Operating Temperature	-20°C to +70°C
Relative Humidity	0% to 100% (non-condensing)
Dimension	105 × 71 × 69.5 mm (Waterproof connector and sensor are not included)
Mounting	Pole, wall, DIN rail

## 1.4 Dimensions(mm)

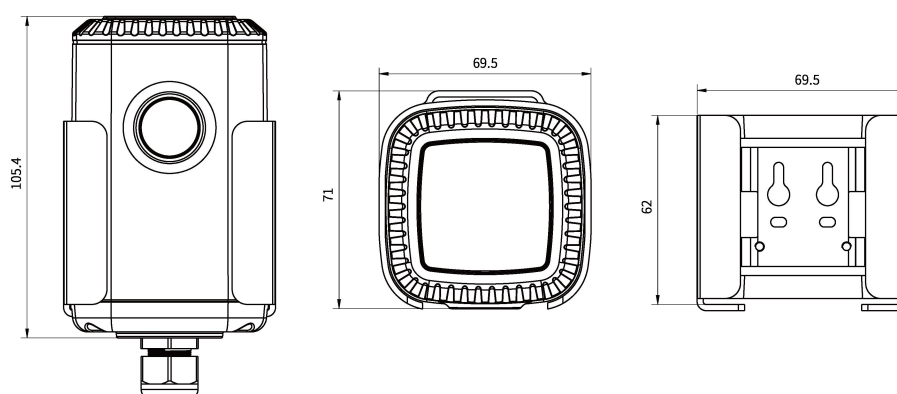

## 2. Hardware Introduction

### 2.1 Packing List

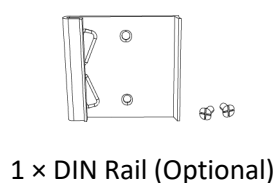
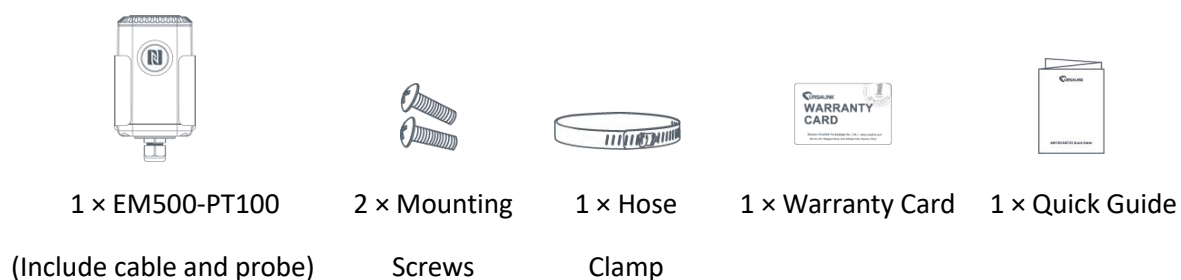

**!** If any of the above items is missing or damaged, please contact your Ursalink sales representative.

## 2.2 Product Overview



### Front View:

- ① LoRa Antenna (Internal)
- ② NFC Area
- ③ Water-proof Connector

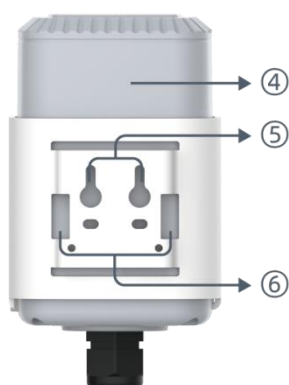

### Back View:

- ④ Battery (Internal)
- ⑤ Wall Mounting Holes
- ⑥ Pole Mounting Holes

## 3. Sensor Connection with EM500

Follow below to connect PT100 sensor cable to EM500 device if they are separated.

1. Take off the mounting bracket, remove the cap, rubber seal and the screws on the bottom of the device, and then take off the enclosure cover.
2. Pass the cable through the cap, rubber seal and enclosure cover.

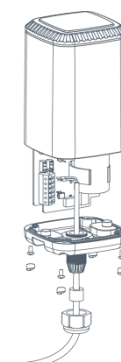
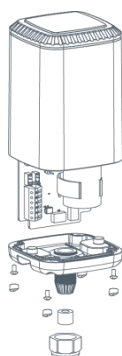

3. Pull out the motherboard, insert and lock the wires accordingly (see the label on the motherboard or following picture).

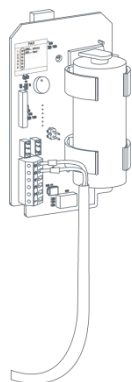

4. Put the motherboard back and restore everything in its due position.

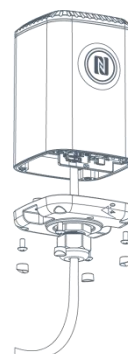

#### Pinouts:

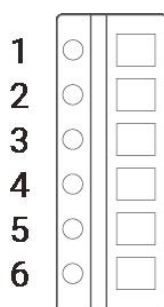

PIN	Color	Description
1	White	GND
2	--	--
3	---	--
4	Red	PT1
5	Red	PT2
6	---	--

**Note:** Select one of the PT cables to connect.

## 4. Sensor Installation

### 4.1 Wall Mounting

1. Attach the mounting bracket to the wall and drill. (Around 16mm)

**Note:** The connecting line of two holes must be a horizontal line.

2. Mount the device on the wall.

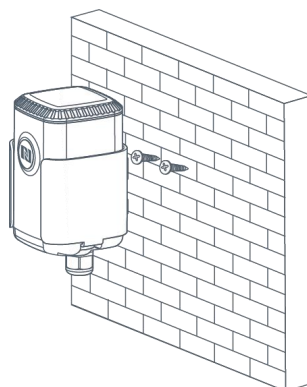

## 4.2 Pole Mounting

1. Loosen the hose clamp by turning the locking mechanism counter-clockwise.



2. Straighten out the hose clamp and slide it through the rectangular holes in the mounting bracket, wrap the hose clamp around the pole.
3. Use a screwdriver to tighten the locking mechanism by turning it clockwise.

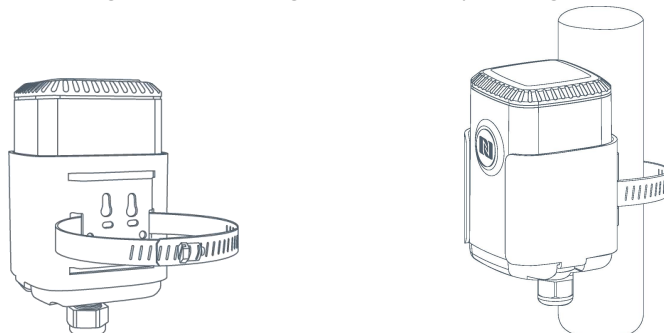

## 4.3 DIN Rail Mounting

Use 2 pieces of M3 × 6 flat head Phillips screws to fix the DIN rail to the device, and then hang the DIN rail on the mounting bracket. It is necessary to choose a standard bracket.

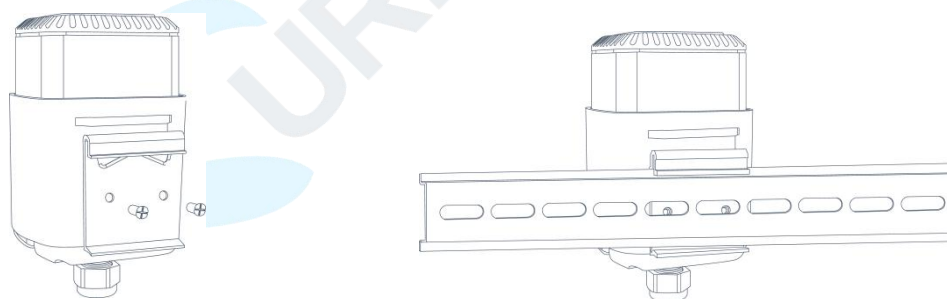

## 5. Turn ON/OFF the Sensor

EM500-PT100 series can be turned ON/OFF via smartphone or computer with NFC (Near Field Communication) or button. Select one of following methods to turn on/off the sensor.

### 5.1 Turn ON/OFF via Smartphone APP

1. Download Ursalink configuration APP “Toolbox” and install it on your smartphone. The smartphone must support NFC.
2. Enable NFC on the smartphone and open the APP.



3. Attach the smartphone with NFC area to the device.

**Note:** Ensure the location of your smartphone NFC area and it is recommended to take off phone case before using NFC.

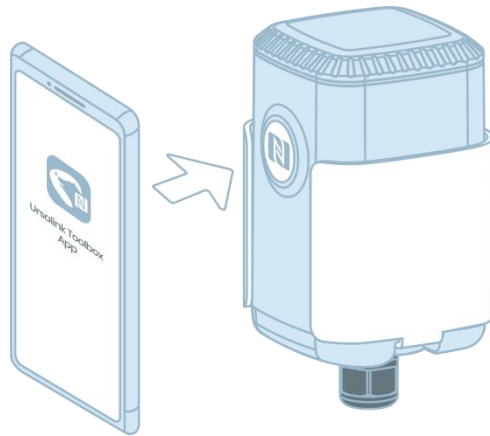

4. Device information will be shown on the APP.

5. Switch the button of Device Status to turn on or off the device.

Status	Setting	Upgrade
SN	6126A10417970048	
Model	EM500-PT100-T200-868	
Device EUI	24e124126a104179	
Firmware Version	V1.1	
Hardware Version	V1.0	
Device Status	ON	<input checked="" type="checkbox"/>
Join Status	Activated	
RSSI/SNR	-61/16	
Temperature	25.0 °C	
Battery	100 %	
Channel Mask	0007	
Uplink Frame Counter	16	

Read

Device
Template

6. Enter the correct password (Default password: 123456) and wait a few seconds until APP shows "Operate Successful!".

**Note:** Keep the two devices close together and do not move them in order that you can get the best connectivity as possible when turning on or off via NFC. No response can be caused by long distance, wrong location or rapid movement.

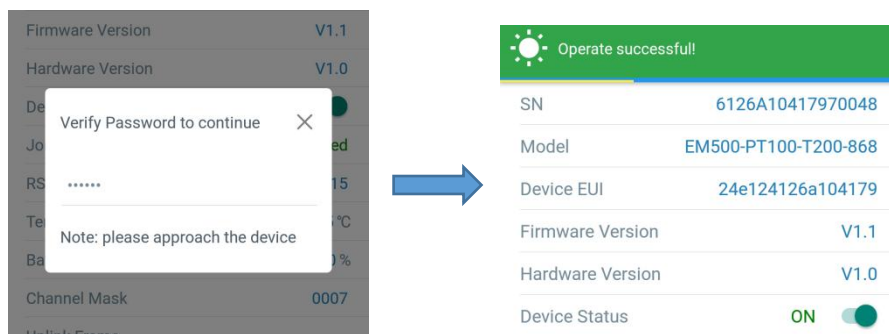

## 5.2 Turn ON/OFF via PC Software

1. Download Ursalink configuration software “Toolbox” and open the software.
2. Connect NFC reader to computer and attach the device to NFC reader.
3. Select type as NFC and serial port of NFC reader, then click “save”.

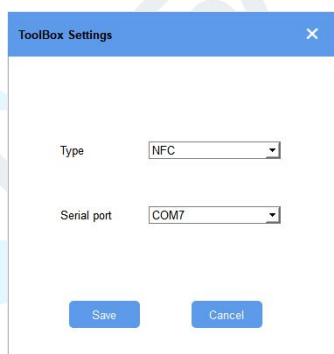
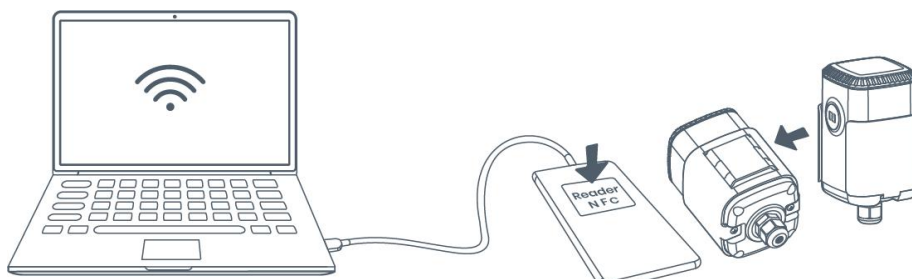

4. Device information will be shown on the software.

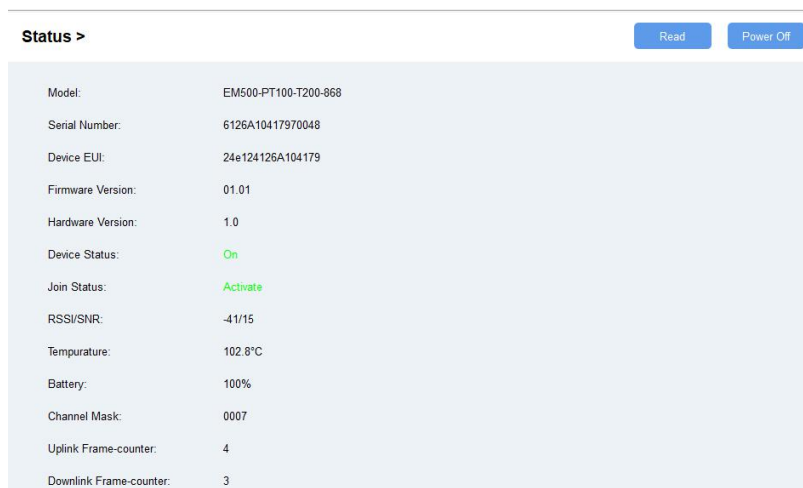

5. Click "Power On" to turn on the device or "Power Off" to turn off the device.
6. Enter password (default password:123456) and press Enter key to change device status.

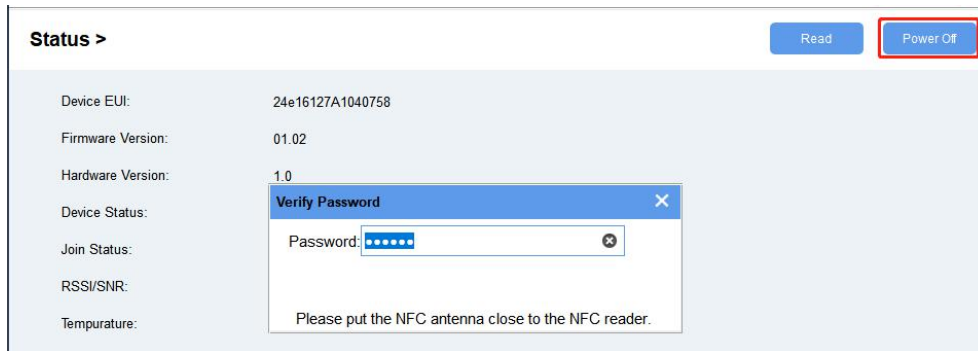

### 5.3 Turn ON/OFF via Button

1. Remove screws on the bottom of EM500-PT100 and take off the upper enclosure.
2. Find the button beside the battery.

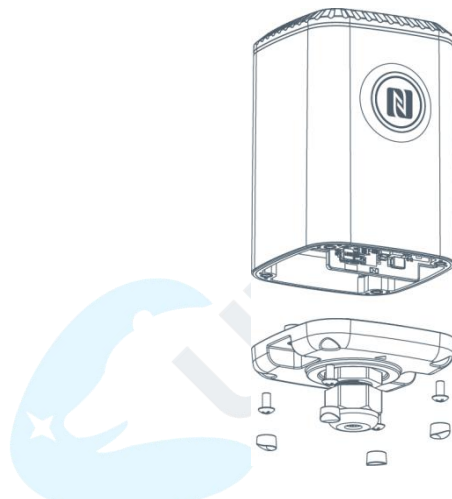

3. Press the button until LED blinks to turn on or off the device. (about 3 seconds)
- Press the button until LED blinks rapidly to reset the device to factory default. (Over 10 seconds)

## 6. Sensor Configuration

Ursalink EM500-PT100 series sensor can be monitored and configured via NFC technology. In order to protect the security of sensor, password validation is required when turning on/off the sensor or changing configuration. Select one of the following ways to configure EM500-PT100 sensors.

### 6.1 Configuration via Smartphone APP

Make sure Ursalink Toolbox APP is downloaded and installed on your smartphone.

### 6.1.1 Read Configuration

1. Open APP "Toolbox" and click "Read" to read current information of device.

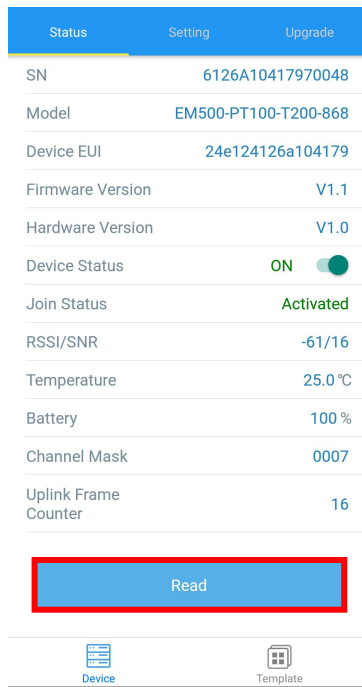

2. Attach the smartphone with NFC area to the device until the APP shows "Read Successfully!".

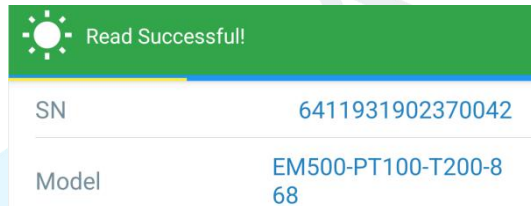

**Note:** Failing to read can be caused by long distance, wrong location, or rapid movement.

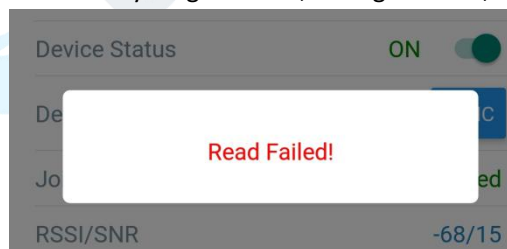

### 6.1.2 Write Configuration

1. Open APP "Toolbox" and go to "Settings" page.
2. Change parameters as required and click "Write".

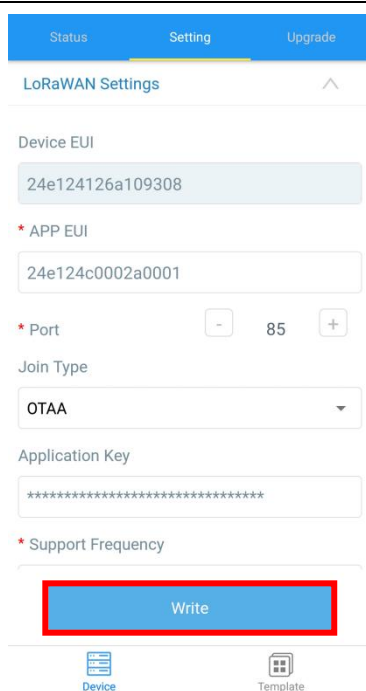

3. Enter password (default password: 123456).
4. Attach the smartphone with NFC area to the device and wait a few seconds until APP shows "Write Successfully!". The device will automatically re-join the network if LoRaWAN parameters are changed.

**Note:** Failing to write can be caused by long distance, wrong location, or rapid movement.

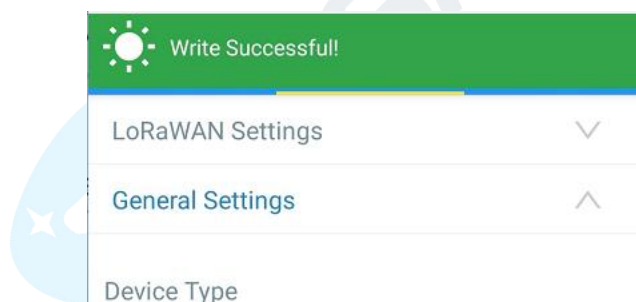

### 6.1.3 Template Settings

Template settings are used for easy and quick device configuration in bulk.

**Note:** Template function is allowed only for sensors with the same model and LoRa frequency band.

1. Go to "Template" page of APP and save current settings as a template.

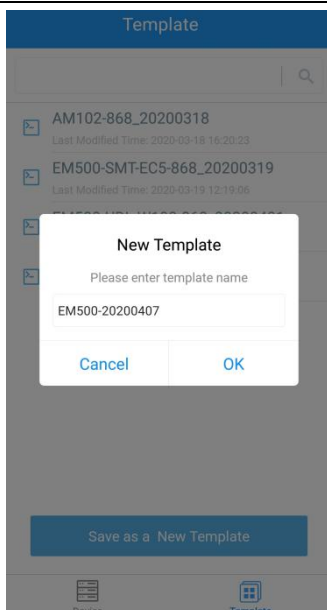

2. Attach the smartphone with NFC area to another device.
3. Select the template file from Toolbox APP and click "Write".

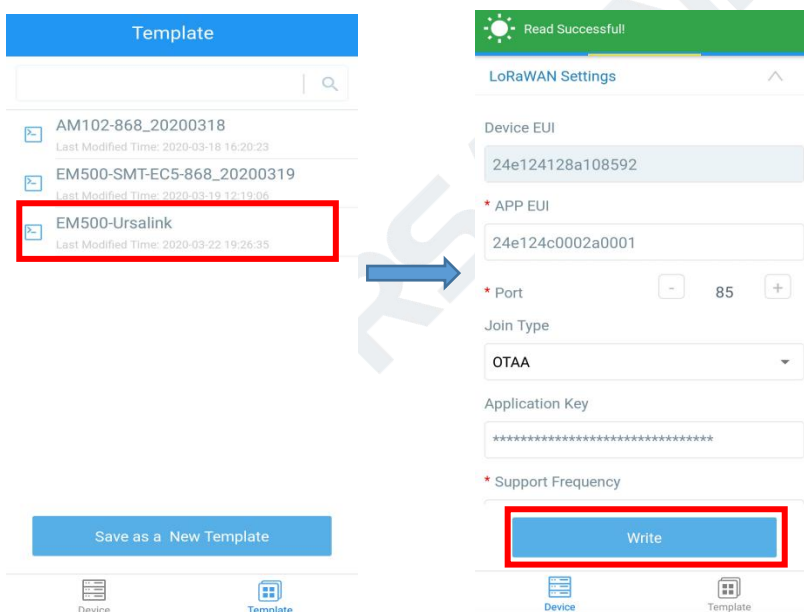

4. Enter password of this device and keep the two devices close until the APP shows "Write successfully!".

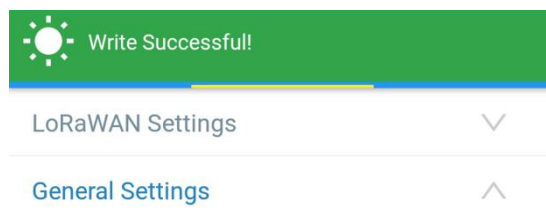

5. Slide the template item left to edit or delete the template.

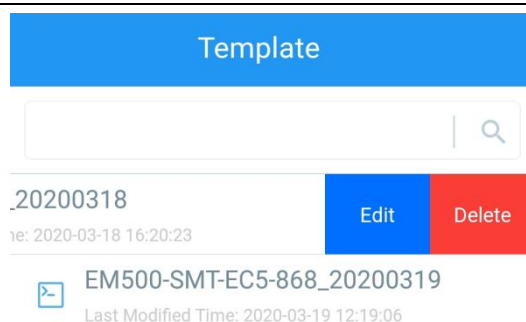

## 6.2 Configuration via PC

Make sure “Toolbox” is downloaded on your computer.

### 6.2.1 Read Configuration

1. Open software “Toolbox” and click “Read” to read current information of device.



3. Attach the device to the NFC reader until Toolbox shows “success”.

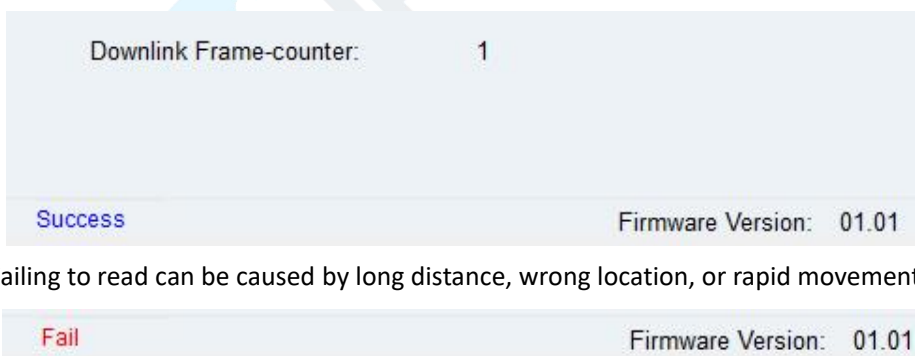

**Note:** Failing to read can be caused by long distance, wrong location, or rapid movement.

### 6.2.2 Write Configuration

1. Go to “Settings” page to change parameters as requirements and click “save”.
2. Click “Write” and enter the correct password (default password: 123456).

LoRaWAN > Read Write

Basic
Channel

Device EUI

Verify Password

Password:

Please put the NFC antenna close to the NFC reader.

Regular Report Confirmed

ADR Mode

Save

3. Press Enter key to write and attach the device close to NFC reader until “Write” button disappear. The device will automatically re-join the network if LoRaWAN paramters are changed.

**Note:** Keep the two devices close and don’t move them in order that you can get the best connectivity as possible when writing data via NFC. Bad connection can be caused by long distance, wrong location, or rapid movement.

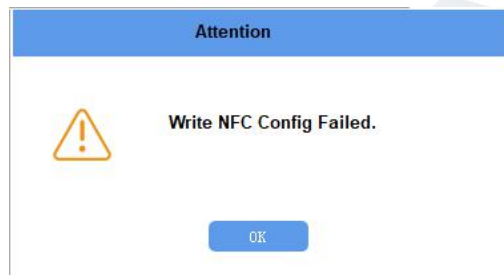

## 6.2.3 Upgrade

### 6.2.3.1 Upgrade Locally

1. Download firmware to your computer.
2. Go to “Maintenance -> Upgrade” in Toolbox.
3. Click “Browse” and select the firmware from computer.
4. Click “Upgrade” and enter password of the device.
5. Press Enter key to start upgrade. Device will check if the firmware is correct. If it is correct, firmware will be imported to the device to upgrade.

**Note:** Keep the two devices close and don’t move them in order that you can get the best connectivity as possible when upgrading. Failing to upgrade can be caused by long distance, wrong location, or rapid movement.



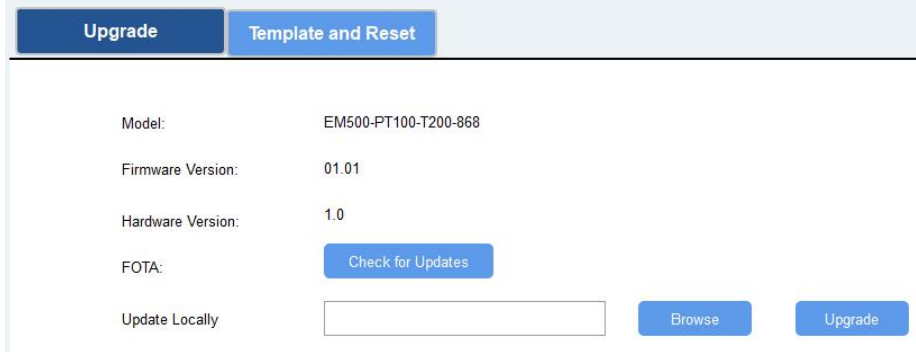

The screenshot shows the 'Template and Reset' section of the interface. At the top, there are two tabs: 'Upgrade' and 'Template and Reset'. Below the tabs, the following information is displayed:

- Model: EM500-PT100-T200-868
- Firmware Version: 01.01
- Hardware Version: 1.0
- FOTA:
- Update Locally:

### 6.2.3.2 FOTA

1. Make sure your computer can access the Internet.
2. Click “Check for Updates” to search for the latest firmware via computer Internet and upgrade.

**Note:** Keep the two devices close and don’t move them in order that you can get the best connectivity as possible when upgrading. Failing to upgrade can be caused by long distance, wrong location, or rapid movement.

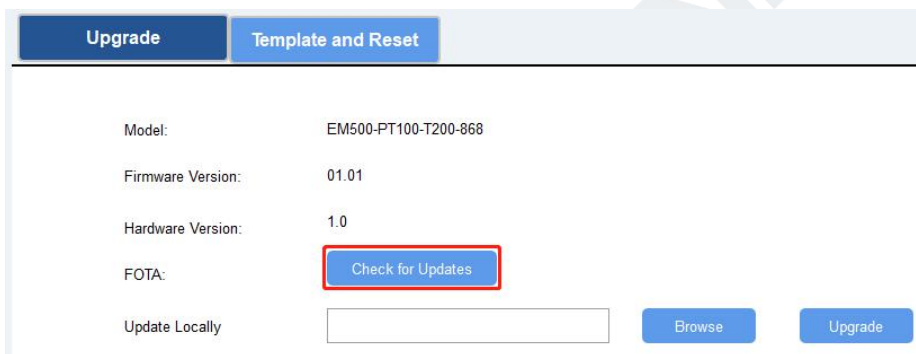

This screenshot is identical to the previous one, but the 'Check for Updates' button under the FOTA section is highlighted with a red rectangular border.

## 6.2.4 Template and Reset

### 6.2.4.1 Template Configuration

1. Go to “Maintenance -> Template and Reset” in Toolbox.
2. Click “Export” to save the current settings as a template.



The screenshot shows the 'Template and Reset' section with the 'Template and Reset' tab selected. The following options are visible:

- Template:
- Config File:
- Restore Factory Defaults:

3. Click “Browse” to select the correct template from computer.
4. Click “Import” to import the template to the device.

### 6.2.4.2 Reset

Click the "Reset" to reset the setting to factory default.

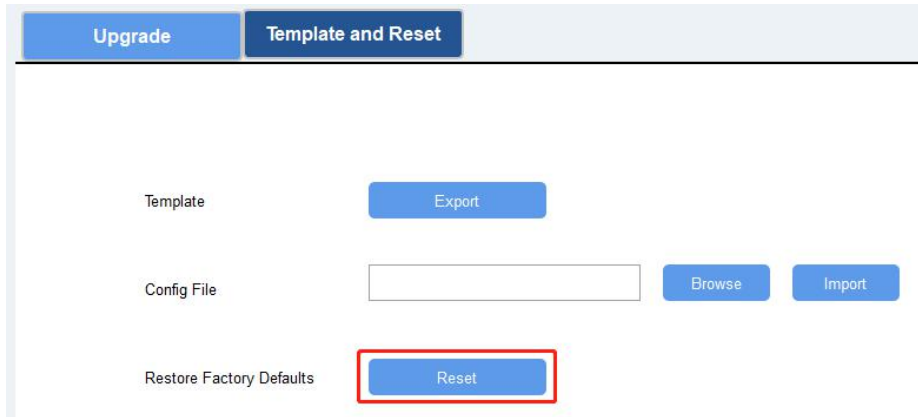

## 6. Sensor Parameters (for App and PC)

### 7.1 LoRa WAN Settings

#### 7.1.1 Basic Settings-OTAA

**Location:**

Ursalink ToolBox(PC): LoRaWAN Settings → Basic

Ursalink ToolBox(APP): Device → Settings → LoRaWAN Settings

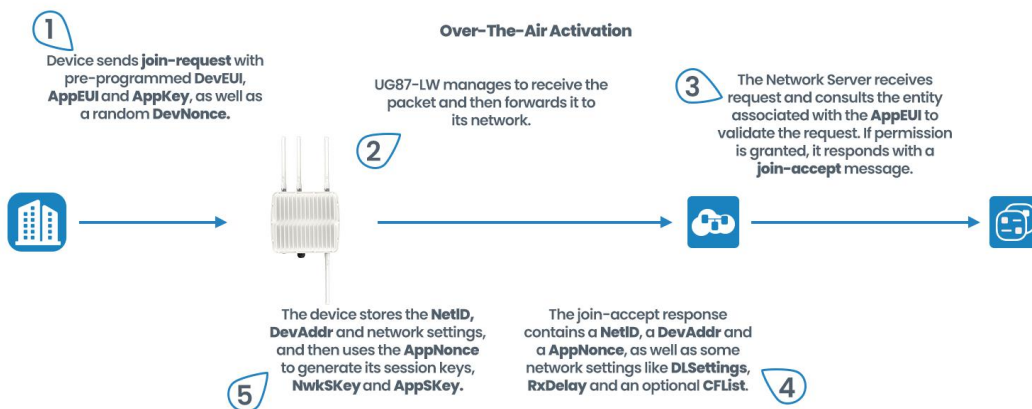

Basic Settings-OTAA		
Item	Description	Default
App EUI	Enter the application EUI.The Network Server receives request and consults the entity associated with the APP EUI to validate the request.If permission is granted, it responds with a join-accept message.	24e124c000 2a0001
Join Type	Select from: "OTAA" and "ABP".	OTAA

	<p>OTAA:Over-the-Air Activation. For over-the-air activation, end-devices must follow a join procedure prior to participating in data exchanges with the network server. An end-device has to go through a new join procedure every time it loses the session context information.</p> <p>ABP: Activation by Personalization. Under certain circumstances, end-devices can be activated by personalization. Activation by personalization directly ties an end-device to a specific network by-passing the join request - join accept procedure.</p>	
Application Key	Enter the application key. Whenever an end-device joins a network via over-the-air activation, the application key is used to derive the Application Session key.	5572404c69 6e6b4c6f526 1323031382 3
Confirmed Mode	<p>After sending the attribute/data/battery packets to the network server, the device will resend these packets if it does not receive ACK bit from the Network Server.</p> <p><b>Note:</b> If the device doesn't receive ACK for a long time, the device will resend confirmed packets 3 times at most. However, the device will resend attribute package all the time.</p>	Disabled
ADR	<p>ADR : Adaptive Data Rate.</p> <p>Enabled: The Network Server will adjust the datarate by MAC command.</p> <p>Disabled: Whatever how the signal quality is, the Network Server will not adjust the datarate of the device.</p>	Enabled

### 7.1.2 Basic Settings-ABP

**Location:**

Ursalink ToolBox(PC): LoRaWAN Settings → Basic

Ursalink ToolBox(APP): Device → Settings → LoRaWAN Setting

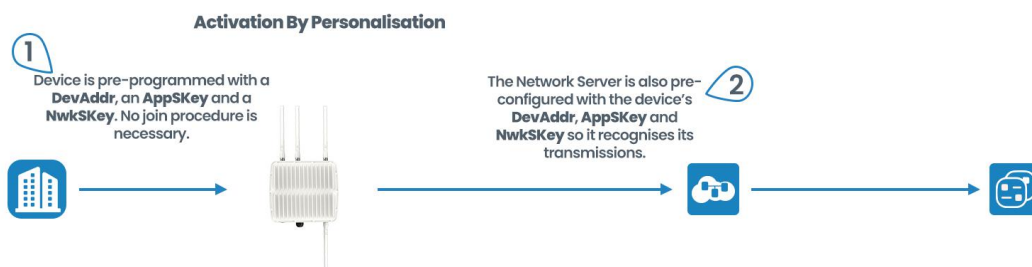

Basic Settings-ABP		
Item	Description	Default
App EUI	Enter the application EUI.The Network Server receives request and consults the entity associated with the APP EUI to validate the request.If permission is granted, it responds with a join-accept message.	24e124c0002 a0001
Join Type	Select from: "OTAA" and "ABP". OTAA:Over-the-Air Activation. For over-the-air activation, end-devices must follow a join procedure prior to participating in data exchanges with the network server. An end-device has to go through a new join procedure every time it has lost the session context information.  ABP: Activation by Personalization. Under certain circumstances, end-devices can be activated by personalization. Activation by personalization directly ties an end-device to a specific network by-passing the join request - join accept procedure.	OTAA
Device Address	Enter the device address. The device address identifies the end-device within the current network.	The 5 <sup>th</sup> to 12 <sup>th</sup> digits number of SN
Network Session Key	Enter the network session key of the device. The network session key specific for the end-device. It is used by the end-device to calculate the MIC or part of the MIC (message integrity code) of all uplink data messages to ensure data integrity.	5572404c696 e6b4c6f5261 3230313823
Application Session Key	Enter the application session key of the device. The AppKey is an application session key specific for the end-device. It is used by both the application server and the end-device to encrypt and decrypt the payload field of application-specific data messages.	5572404c696 e6b4c6f5261 3230313823
Confirmed Mode	After sending the attribute/data/battery packets to the network server, the device will resend these packets if it does not receive ACK bit from the Network Server.  <b>Note:</b> If the device doesn't receive ACK for a long time, the device will resend confirmed packets 3 times at most. However, the device will resend attribute package all the time.	Disabled
ADR	ADR : Adaptive Data Rate. Enabled: The Network Server will adjust the datarate	Enabled

	<p>by MAC command.</p> <p>Disabled: Whatever how the signal quality is, the Network Server will not adjust the datarate of the device.</p>	
--	--	--

### 7.1.3 Channel Settings

**Location:**

Ursalink ToolBox(PC): LoRaWAN Settings → Channel

Ursalink ToolBox(APP): Device → Settings → LoRaWAN Settings

**Note:** Make sure the LoRa channel configuration of EM500-PT100 matches the LoRaWAN gateway.

LoRa frequency configuration is as follows if the sensor LoRa frequency is one of EU433/EU868/RU864/IN865/AS923/KR920:

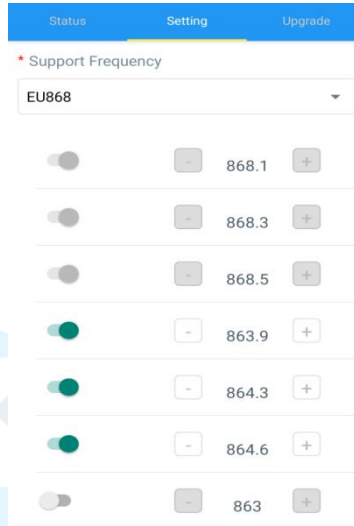

LoRa frequency configuration is as follows if the sensor LoRa frequency is one of CN470/US915/AU915:



Enter the index of the channel to be enabled in the input box, separated by commas.

**Example:**

1, 40: Enabling Channel 1 and Channel 40

1-40: Enabling Channel 1 to Channel 40

1-40, 60: Enabling Channel 1 to Channel 40 and Channel 60

All: Enabling all channels

Null: Indicates that all channels are disabled

**Note:**

For US915:

64 channels numbered 0 to 63 utilize LoRa 125 kHz BW starting at 902.3 MHz and incrementing linearly by 0.2 MHz to 914.9.

8 channels numbered 64 to 71 utilize LoRa 500 kHz BW starting at 903.0 MHz and incrementing linearly by 1.6 MHz to 914.2.

For AU915:

64 channels numbered 0 to 63 utilize LoRa 125 kHz BW starting at 915.2 MHz and incrementing linearly by 0.2 MHz to 927.8.

8 channels numbered 64 to 71 utilize LoRa 500 kHz BW starting at 915.9 MHz and incrementing linearly by 1.6 MHz to 927.1.

For CN470:

80 channels numbered 0 to 79 utilize LoRa 125 kHz BW starting at 470.3 MHz and incrementing linearly by 0.2 MHz to 486.1.

16 channels numbered 80 to 95 utilize LoRa 125 kHz BW starting at 486.3 MHz and incrementing linearly by 1.6 MHz to 489.3.

## 7.2 Device Settings

### 7.2.1 General

**Location:**

Ursalink ToolBox(PC): Device Settings → General

Ursalink ToolBox(APP): Device → Settings → General Settings

Device General Settings		
Item	Description	Default
Device Type	Show the type of the device.	Null
Reporting Interval	The sensor reports the sampling data at regular intervals. Range: 5-30 (mins)	10
Temperature Unit	Configure the unit of temperature shown on the screen and status page. <b>Note:</b> Threshold settings should be changed after changing unit.	°C

Change Password	Change the password used for changing device status and writing configuration.	Disabled
-----------------	--	----------

## 7.2.2 Data Calibration

### Location:

Ursalink ToolBox(PC): Device Settings → Data Calibration Settings

Ursalink ToolBox(APP): Device → Settings → Data Calibration Settings

**Note:** It is recommended to do the calibration before using the device.

Data Calibration Settings		
Item	Description	Default
Enable	Enable calibration.	Disabled
Current Raw Value	The current value.	Null
Calibration Button	Click to reset value to 0.	Null
Temperature Calibration	Enter the calibration value for temperature. <b>Note:</b> only one decimal is allowed.	Null
Final Value	Adjusted value.	Null
Abnormal Value Prevention	Enable abnormal value prevention.	Disabled
Set Value	Setting value= $ A - B  / C * 100\%$ . (A=current measured value; B=previous measured value; C=maximum range) If the current measured value exceeds the set value after calculation by the previous formula, it is abnormal and device will measure again.	Null

## 7.2.3 Threshold

### Location:

Ursalink ToolBox(PC): Device Settings → Threshold Settings

Ursalink ToolBox(APP): Device → Settings → Threshold Settings

Threshold Settings		
Item	Description	Default
Temperature	Enable: The device will send the latest temperature value to network server if the temperature goes above/below temperature thresholds.	Disabled
Over	Enter the maximum temperature threshold.	Null
Below	Enter the minimum temperature threshold.	Null

**Example:** Set the "Lockout Time" for 10min, "Duration" for 5min.

The device will report the detected value immediately when the value reaches the threshold and last for 5mins. After that, the device will check the detected value every 10 mins, and report the value again if it reaches the threshold and last for 5mins.

## 8.Sensor Management via Ursalink Cloud

Ursalink cloud is a comprehensive platform that provides multiple services including device remote management and data visualization with the easiest operation procedures.

### 8.1 Ursalink Cloud Registration

Register and log in Ursalink Cloud.

Ursalink Cloud URL: <https://cloud.ursalink.com/login.html>

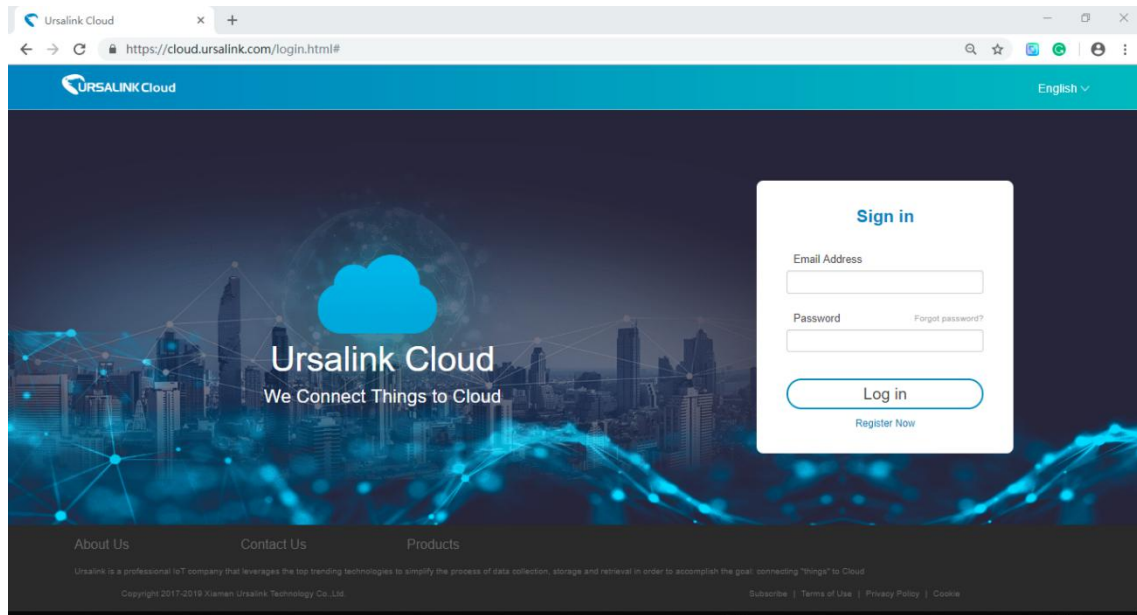



### 8.2 Add a Ursalink LoRaWAN Gateway

1. Enable “Ursalink” type network server and “Ursalink Cloud” mode in gateway web GUI.

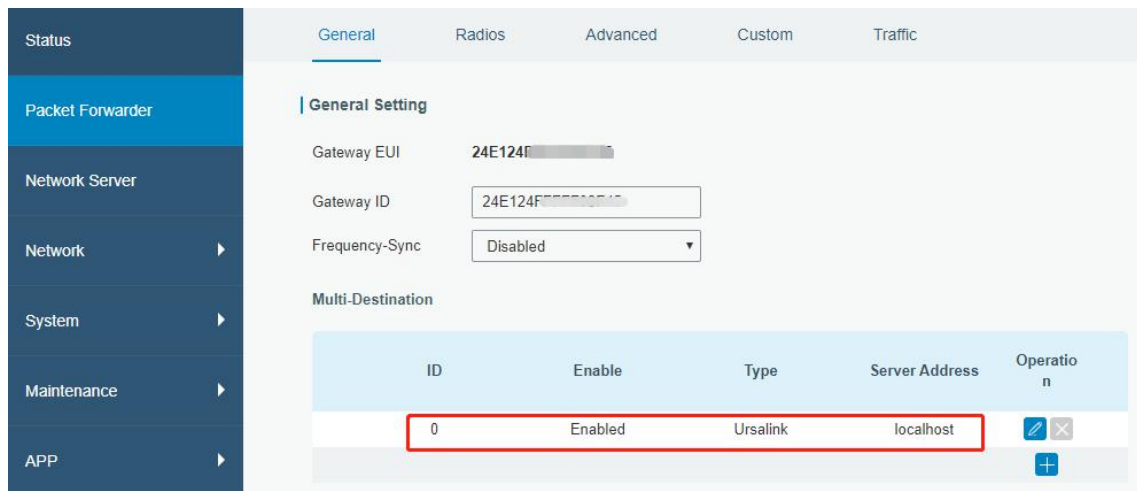
**Note:** Ensure gateway has accessed the Internet.



ID	Enable	Type	Server Address	Operation
0	Enabled	Ursalink	localhost	 
				



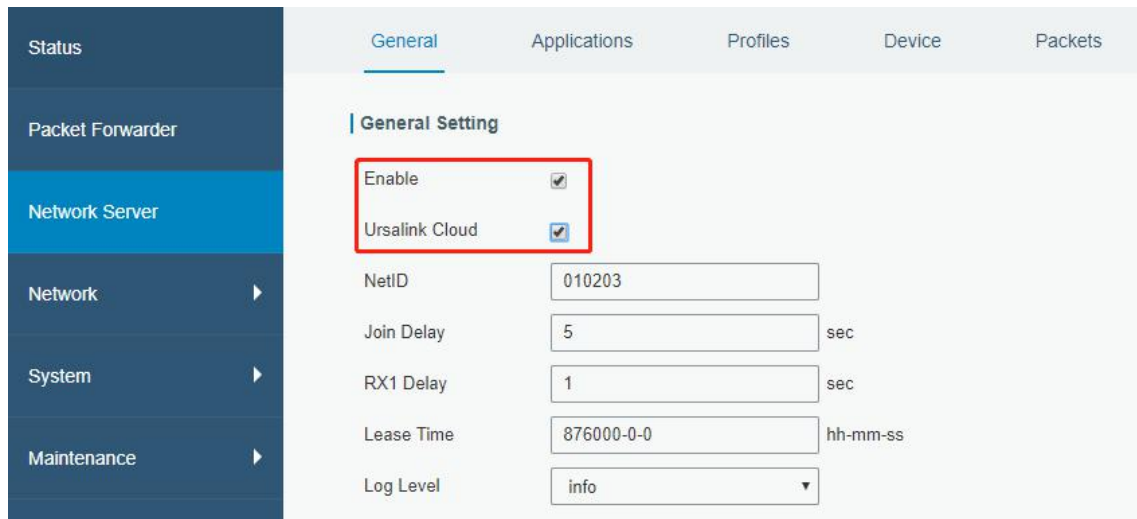

The screenshot shows the 'General Setting' tab for a device. The 'Enable' and 'Ursalink Cloud' checkboxes are checked and highlighted with a red box. Other settings include NetID (010203), Join Delay (5 sec), RX1 Delay (1 sec), Lease Time (876000-0-0 hh-mm-ss), and Log Level (info).

2. Go to “My Devices->Gateway” of Ursalink Cloud and click “Add” to add gateway to Ursalink Cloud via SN.

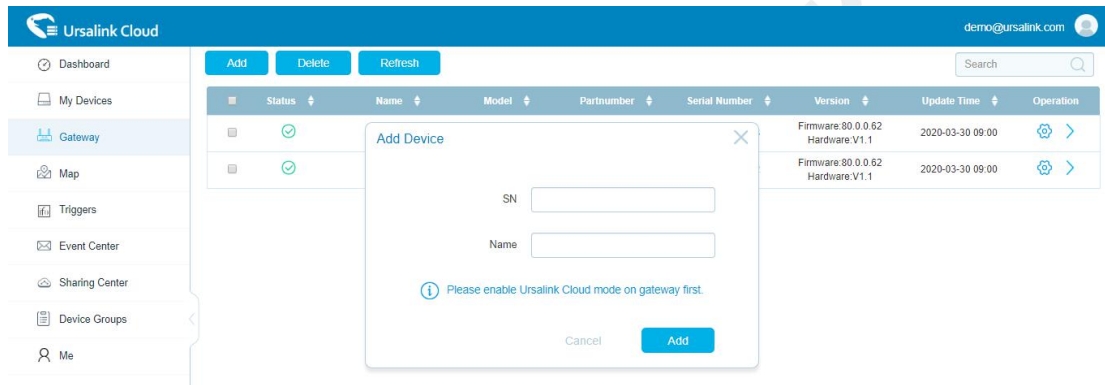

The screenshot shows the 'Ursalink Cloud' interface with the 'Add Device' dialog box open. The dialog box has fields for SN and Name, and a message: "Please enable Ursalink Cloud mode on gateway first." The background shows a table of devices with columns for Status, Name, Model, Partnumber, Serial Number, Version, Update Time, and Operation.

3. Check if gateway is online in Ursalink Cloud.



The screenshot shows the 'Ursalink Cloud' interface with a table of devices. The table has columns for Status, Name, Model, Partnumber, Serial Number, Version, Update Time, and Operation. The table contains two rows of data:

Status	Name	Model	Partnumber	Serial Number	Version	Update Time	Operation
✓	231	UG85-L00E-EU888	L00E-EU888	621750000000	Firmware:80.0.0.62 Hardware:V1.1	2020-03-30 09:00	⚙️ >
✓	621793195782	UG85-L01CE-CN470	L01CE-CN470	621750000000	Firmware:80.0.0.62 Hardware:V1.1	2020-03-30 09:00	⚙️ >

## 8.3 Add EM500-PT100 to Cloud

1. Go to “Device->My Devices” and click “Add Device”. Fill in the SN of EM500-PT100 and select associated gateway.

Add Device
✕

SN

Name

Associated Gateway

Device EUI

Application Key

Cancel
Add

2. After EM500-PT100 is connected to Ursalink Cloud, Click  or “History Data” to check the data on Ursalink cloud.



-END-