



EM500-UDL User Guide



www.ursalink.com

Safety Precautions

Ursalink will not shoulder responsibility for any loss or damage resulting from not following the instructions of this operating guide.

- ❖ The device must not be disassembled or remodeled in any way.
- ❖ Please clarify your application environment before deployment so that the device can function well.
- ❖ The device is not intended to be used as a reference sensor, and Ursalink will not should responsibility for any damage which may result from inaccurate readings.
- ❖ Do not place the device in places that are already out of measuring range or where the temperature is below/above the operating range .
- ❖ Make sure electronic components do not drop out of the enclosure while opening.
- ❖ When closing the lid, make sure the lid is fitted the right way, so that the enclosure is properly sealed.
- ❖ When installing the battery, please install it accurately, not reversely or with wrong model.
- ❖ The device must never be subjected to shocks or impacts.

Declaration of Conformity

Ursalink EM500-UDL is in conformity with the essential requirements and other relevant provisions of the CE, FCC, and RoHS.



© 2017-2020 Xiamen Ursalink Technology Co., Ltd.

All rights reserved.

All information in this guide is protected by copyright law. Whereby, no organization or individual shall copy or reproduce the whole or part of this user guide by any means without written authorization from Xiamen Ursalink Technology Co., Ltd.

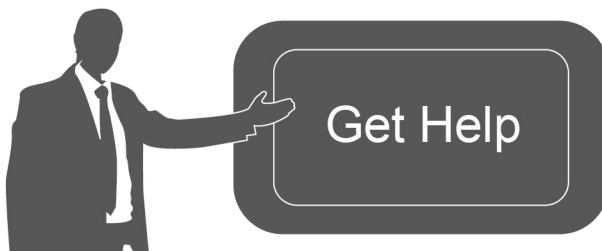

For assistance, please contact
Ursalink technical support:
Email: helpdesk@ursalink.com
Tel: 86-592-5023060
Fax: 86-592-5023065

Revision History

Date	Doc Version	Description
April 7, 2020	V 1.0	Initial version

Contents

1. Overview.....	4
1.1 Description.....	4
1.2 Features.....	4
1.3 Specifications.....	4
1.4 Dimensions(mm).....	5
2. Hardware Introduction.....	5
2.1 Packing List.....	5
2.2 Product Overview.....	6
3. Sensor Installation.....	6
3.1 Installation Location.....	6
3.2 Wall Mounting.....	7
3.3 Pole Mounting.....	7
3.4 DIN Rail Mounting.....	8
4. Turn ON/OFF the Sensor.....	8
4.1 Turn ON/OFF via Smartphone APP.....	8
4.2 Turn ON/OFF via PC Software.....	10
4.3 Turn ON/OFF via Button.....	11
5. Sensor configuration.....	11
5.1 Configuration via Smartphone APP.....	11
5.1.1 Read Configuration.....	12
5.1.2 Write Configuration.....	12
5.1.3 Template Settings.....	13
5.2 Configuration via PC.....	15
5.2.1 Read Configuration.....	15
5.2.2 Write Configuration.....	15
5.2.3 Upgrade.....	16
5.2.4 Template and Reset.....	17
6. Sensor Parameters (for App and PC).....	19
6.1 LoRa WAN Settings.....	19
6.1.1 Basic Settings-OTAA.....	19
6.1.2 Basic Settings-ABP.....	20
6.1.3 Channel Settings.....	21
6.2 Device Settings.....	23
6.2.1 General.....	23
6.2.2 Data Calibration.....	23
6.2.3 Threshold.....	24
7. Sensor Management via Ursalink Cloud.....	24
7.1 Ursalink Cloud Registration.....	24
7.2 Add a Ursalink LoRaWAN Gateway.....	25
7.3 Add EM500-UDL to Cloud.....	26

1. Overview

1.1 Description

EM500-UDL is an outdoor environment monitoring sensor mainly used to measure distance without object interface contact. EM500-UDL device is battery powered and designed for multiple mounting ways. It is equipped with NFC (Near Field Communication) and can easily be configured from a smartphone or a PC software.

Sensor data are transmitted in real-time using standard LoRaWAN protocol. LoRaWAN enables encrypted radio transmissions over long distance while consuming very little power. The user can obtain sensor data and view the trend of data change through Ursalink Cloud or through the user's own Network Server.

1.2 Features

- Distance detection without immediate contact
- Up to 11km communication range
- Easy configuration via NFC
- Standard LoRaWAN support
- Ursalink Cloud compliant
- Low power consumption with 19000mAh replaceable battery

1.3 Specifications

LoRaWAN	
Frequency	EU433/CN470/IN865/RU864/EU868/US915/AU915/KR920/AS923
Tx Power	20dBm
Sensitivity	-147dBm @300bps
Mode	OTAA/ABP Class A
Antenna	Embedded Ceramic Antenna
Distance Measurement	
Range	EM500-UDL-W050: 0.3-5m EM500-UDL-W100: 0.5-10m (Customize for snow level detection)
Resolution	1 mm
Accuracy	± 1%
Physical Characteristics	
Power Supply	19000 mAh Li-SoCl ₂ battery

Battery Life	6 year (10 min interval, SF12) >10 year (10 min interval, SF7)
Operating Temperature	-20°C to +70°C
Relative Humidity	0% to 100% (non-condensing)
Dimension	156.1 × 71 × 69.5 mm
Mounting	Pole, wall, DIN rail

1.4 Dimensions(mm)

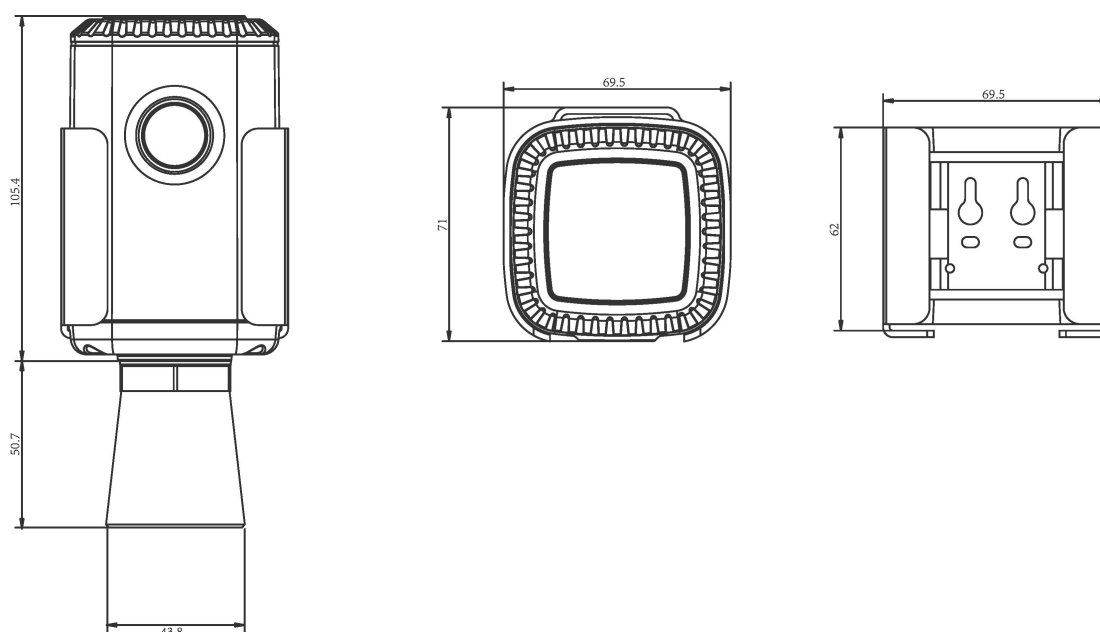

2. Hardware Introduction

2.1 Packing List





If any of the above items is missing or damaged, please contact your Ursalink sales representative.

2.2 Product Overview



Front View:

- ① LoRa Antenna (Internal)
- ② NFC Area
- ③ Ultrasonic Horn

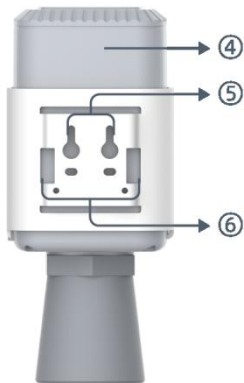

Back View:

- ④ Battery (Internal)
- ⑤ Wall Mounting Holes
- ⑥ Pole Mounting Holes

3. Sensor Installation

3.1 Installation Location

When installing EM500-UDL, please take in mind:

- Ensure the location of EM500-UDL is within the communication range of LoRaWAN gateway.
- Device must sit in a vertical position on top of the object and be fitted such that it has a clear path to the object.
- Place device where it is not close to side-wall and without internal obstructions that block the ultrasonic signal. (Position 1)
- Position 2 is the ideal location to install EM500-UDL.
- Do not place device in the center of arched or circular container tops since it will cause multiple echos. (Position 3)
- Do not place the device above the container inlet orifice.(Position 4)

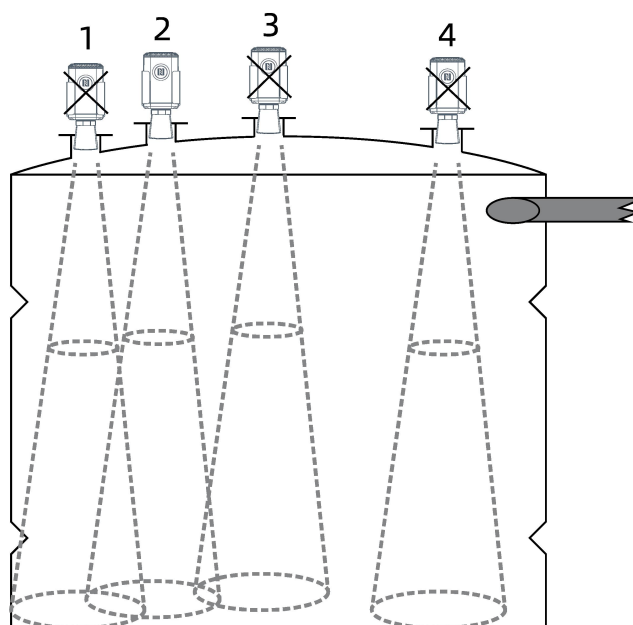

3.2 Wall Mounting

1. Attach the mounting bracket to the wall and drill. (Around 16mm)

Note: The connecting line of two holes must be a horizon line.

2. Drive two screws into wall at the marks using screw driver.
3. Mount the device on the wall.

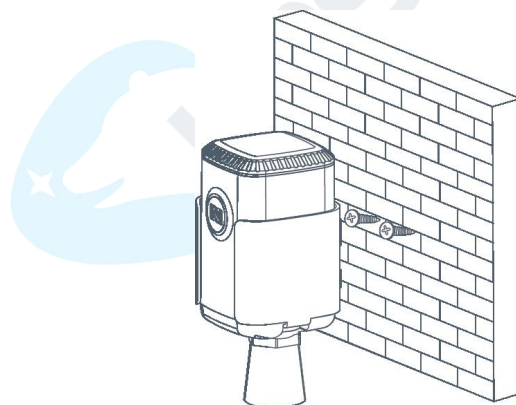

3.3 Pole Mounting

1. Loosen the hose clamp by turning the locking mechanism counter-clockwise.



2. Straighten out the hose clamp and slide it through the rectangular holes in the mounting bracket, wrap the hose clamp around the pole.
3. Use a screwdriver to tighten the locking mechanism by turning it clockwise.

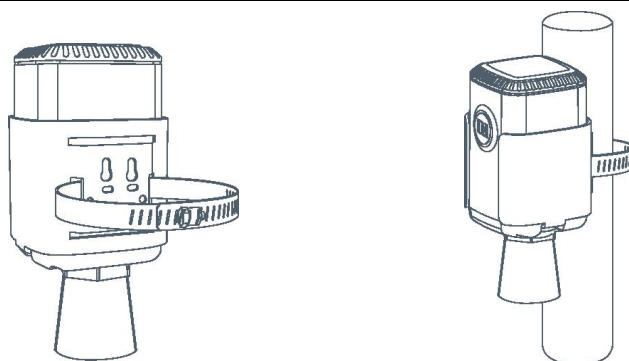

3.4 DIN Rail Mounting

Use 2 pieces of M3 × 6 flat head Phillips screws to fix the DIN rail to the device, and then hang the DIN rail on the mounting bracket. It is necessary to choose a standard bracket.

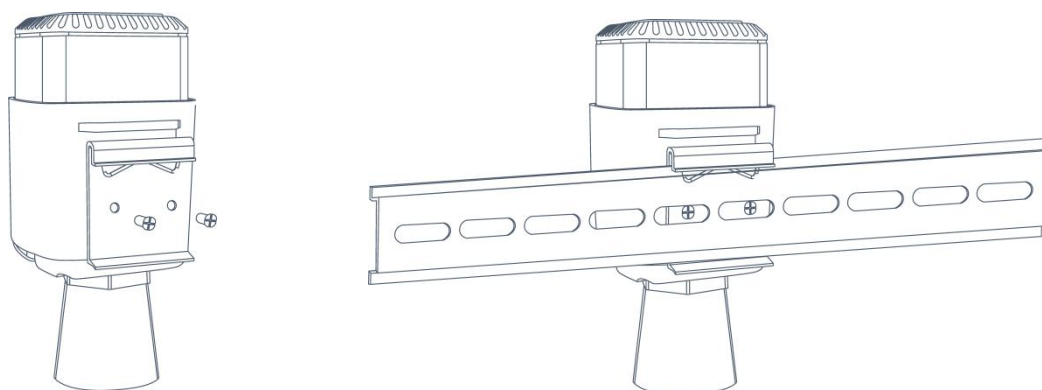

4. Turn ON/OFF the Sensor

EM500-UDL can be turned ON/OFF via smartphone or computer with NFC (Near Field Communication) or button. Select one of following methods to turn on/off the sensor.

4.1 Turn ON/OFF via Smartphone APP

1. Download Ursalink configuration APP “Toolbox” and install it on your smartphone. The smartphone must support NFC.
2. Enable NFC on the smartphone and open the APP.
3. Attach the smartphone with NFC area to the device.

Note: Ensure the location of your smartphone NFC area and it is recommended to take off phone case before using NFC.

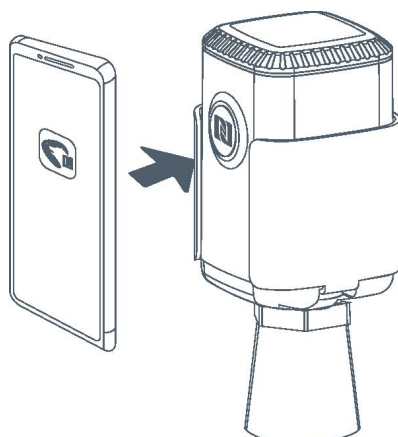

4. Device information will be shown on the APP.
5. Switch the button of Device Status to turn on or off the device.

Status	Setting	Upgrade
SN	6126A10930850025	
Model	EM500-UDL-W100-868	
Device EUI	24e124126a109308	
Firmware Version	V1.1	
Hardware Version	V1.0	
Device Status	ON	<input checked="" type="checkbox"/>

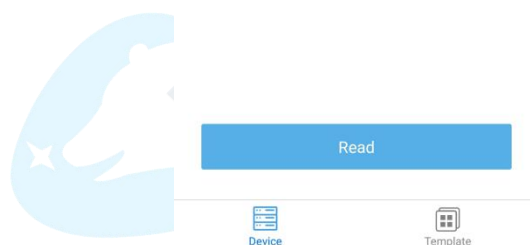

6. Enter the correct password (default password: 123456) and wait a few seconds until APP shows "Operate Successful!".

Note: Keep the two devices close together and do not move them in order that you can get the best connectivity as possible when turning on or off via NFC. No response can be caused by long distance, wrong location or rapid movement.

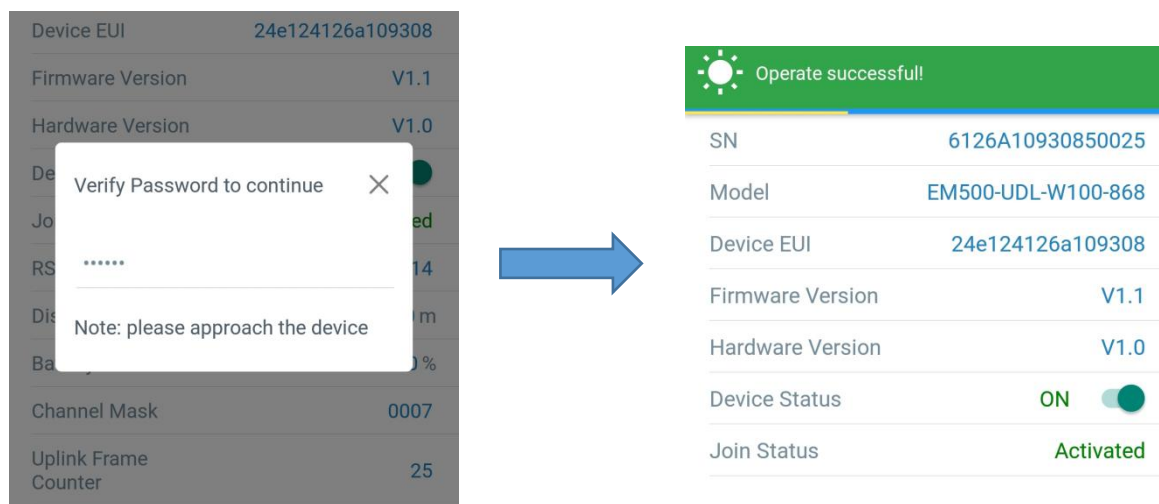

The image shows a transition from a configuration screen to a successful operation screen. On the left, a configuration screen displays various parameters: Device EUI (24e124126a109308), Firmware Version (V1.1), Hardware Version (V1.0), Channel Mask (0007), and Uplink Frame Counter (25). A dialog box prompts for a password with the note: "Note: please approach the device". A blue arrow points to the right, where a green banner reads "Operate successful!". Below the banner, a table lists device details:

SN	6126A10930850025
Model	EM500-UDL-W100-868
Device EUI	24e124126a109308
Firmware Version	V1.1
Hardware Version	V1.0
Device Status	ON <input checked="" type="checkbox"/>
Join Status	Activated

4.2 Turn ON/OFF via PC Software

1. Download Ursalink configuration software "Toolbox" and open the software.
2. Connect NFC reader to computer and attach the device to NFC reader.
3. Select type as NFC and serial port of NFC reader, then click "save".

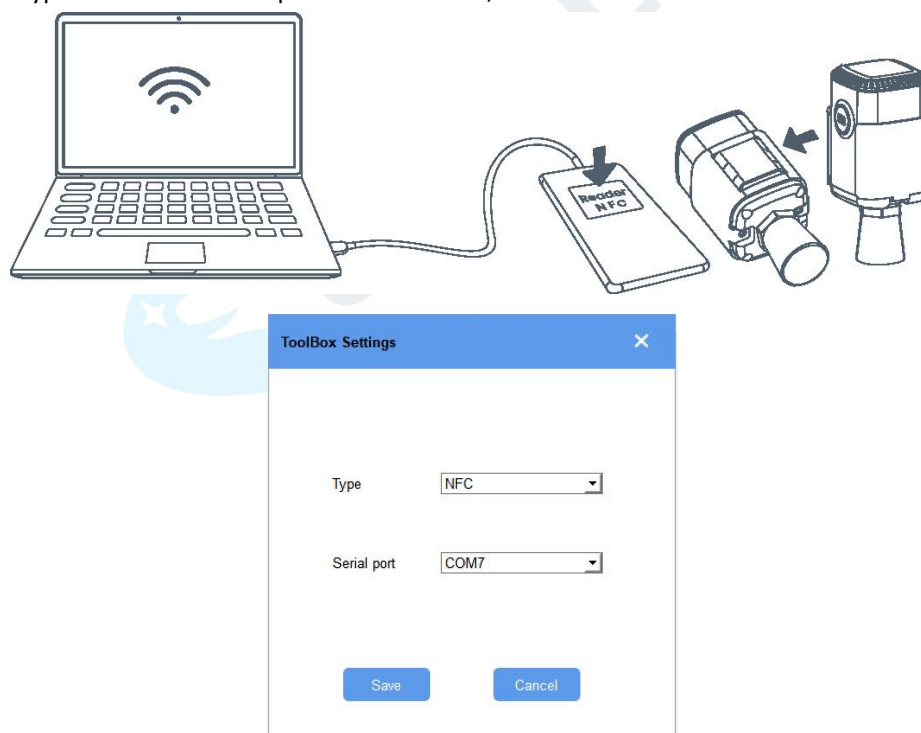

5. Device information will be shown on the software.



- Click "Power On" to turn on the device or "Power Off" to turn off the device.
- Enter password (default password:123456) and press Enter key to change device status.

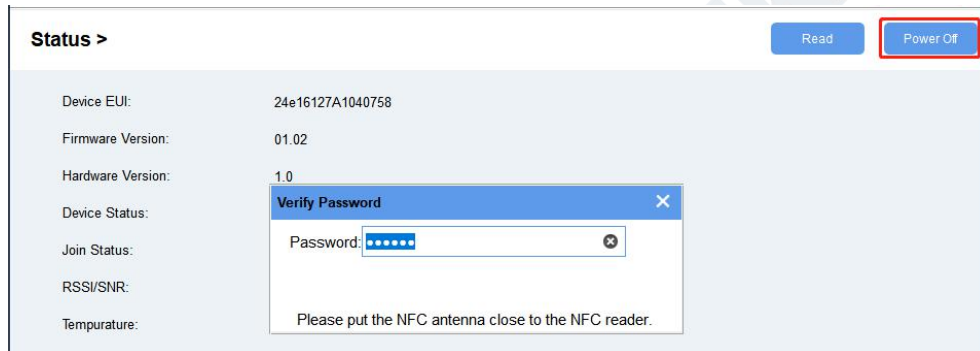

4.3 Turn ON/OFF via Button

- Remove screws on the bottom of EM500-UDL and take off the upper enclosure.
- Find the button beside the battery.
- Press the button until LED blinks to turn on or off the device. (about 3 seconds)
Press the button until LED blinks rapidly to reset the device to factory default. (Over 10 seconds)

5.Sensor configuration

Ursalink EM500-UDL sensor can be monitored and configured via NFC technology. In order to protect the security of sensor, password validation is required when turning on/off the sensor or changing configuration. Select one of the following ways to configure EM500-UDL sensors.

5.1 Configuration via Smartphone APP

Make sure Ursalink Toolbox APP is downloaded and installed on your smartphone.

5.1.1 Read Configuration

1. Open APP "Toolbox" and click "Read" to read current information of device.

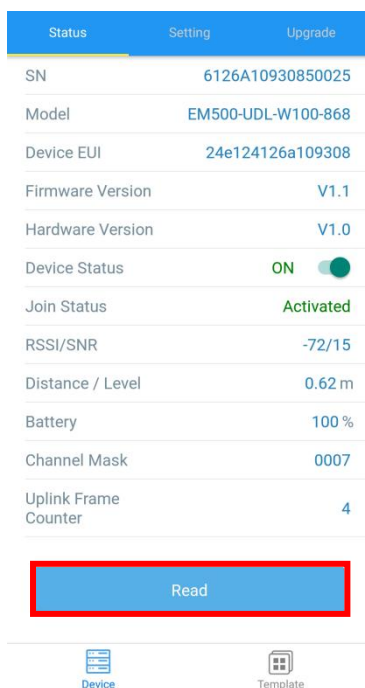

1. Attach the smartphone with NFC area to the device until the APP shows "Read Successful!".



Note: Failing to read can be caused by long distance, wrong location, or rapid movement.

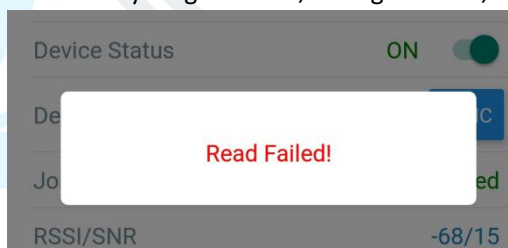

5.1.2 Write Configuration

1. Open APP "Toolbox" and go to "Settings" page.
2. Change parameters as required and click "Write".

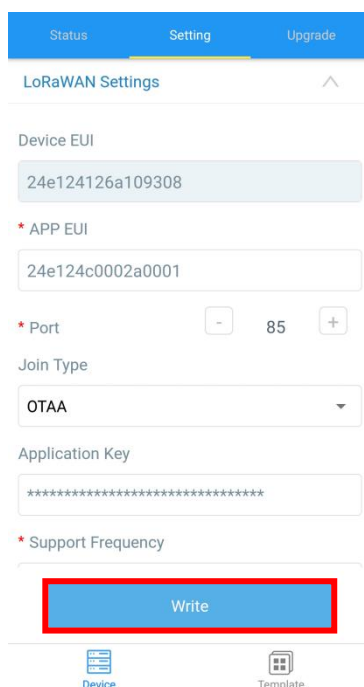

The screenshot shows the 'Setting' tab of the URSA LINK app. Under 'LoRaWAN Settings', the following fields are visible:

- Device EUI: 24e124126a109308
- * APP EUI: 24e124c0002a0001
- * Port: 85 (with minus and plus buttons)
- Join Type: OTAA (dropdown menu)
- Application Key: *****
- * Support Frequency: (empty field)

A blue 'Write' button is highlighted with a red border at the bottom of the settings section. Below the settings are icons for 'Device' and 'Template'.

3. Enter password (default password: 123456).
4. Attach the smartphone with NFC area to the device and wait a few seconds until APP shows "Write Successful!". The device will automatically re-join the network if LoRaWAN parameters are changed.

Note: Failing to write can be caused by long distance, wrong location, or rapid movement.

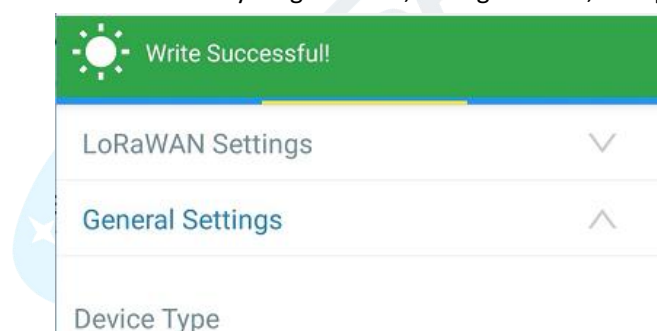

5.1.3 Template Settings

Template settings are used for easy and quick device configuration in bulk.

Note: Template function is allowed only for sensors with the same model and LoRa frequency band.

1. Go to "Template" page of APP and save current settings as a template.

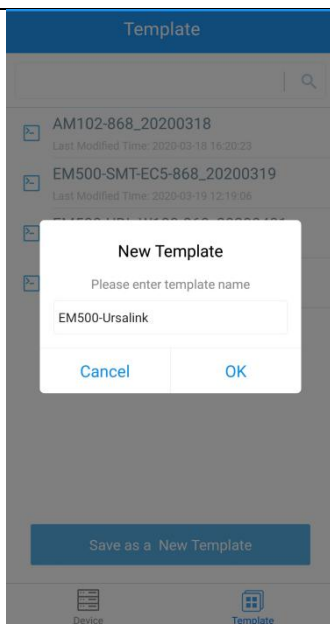

2. Attach the smartphone with NFC area to another device.
3. Select the template file from Toolbox APP and click “Write”.

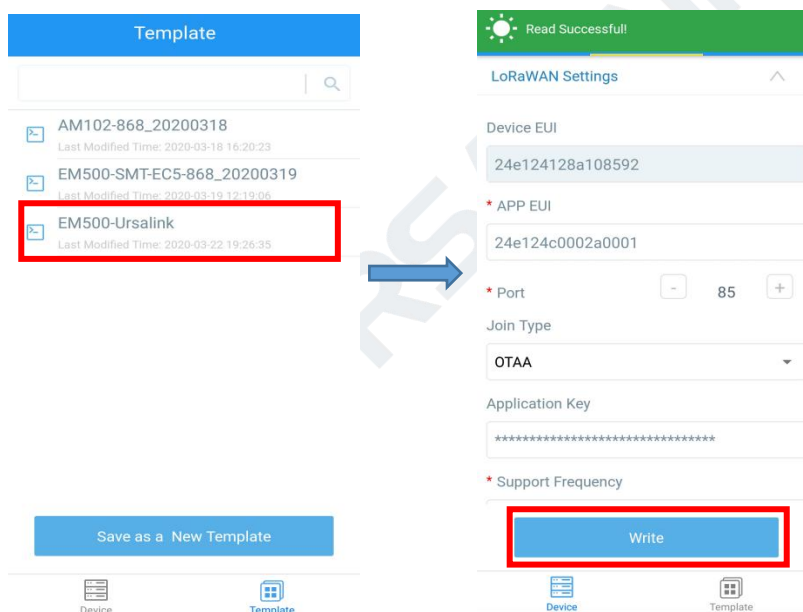

4. Enter password of this device and keep the two devices close until the APP shows “Write successful!”.

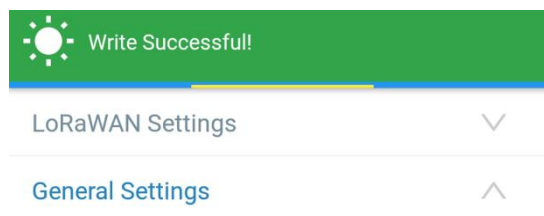

5. Slide the template item left to edit or delete the template.

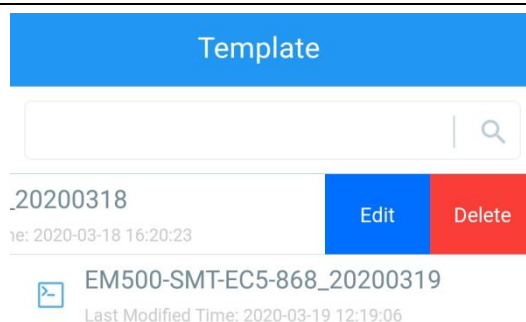

5.2 Configuration via PC

Make sure “Toolbox” is downloaded on your computer.

5.2.1 Read Configuration

1. Open software “Toolbox” and click “Read” to read current information of device.

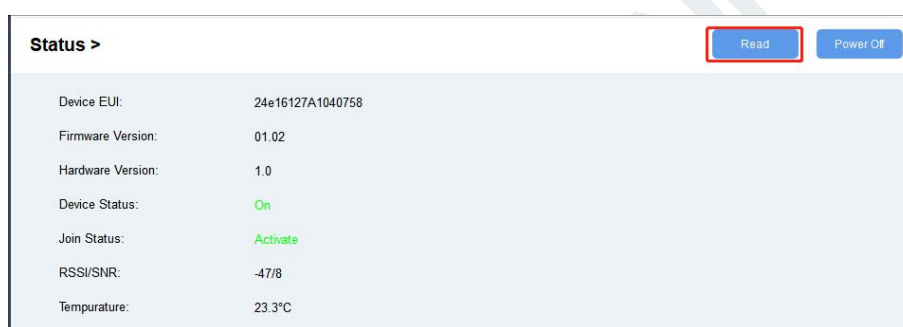

3. Attach the device to the NFC reader until Toolbox shows “success”.

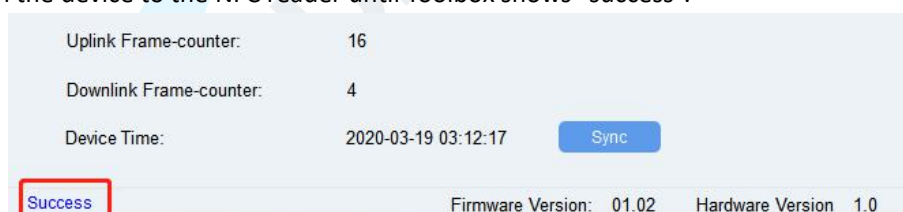

Note: Failing to read can be caused by long distance, wrong location, or rapid movement.

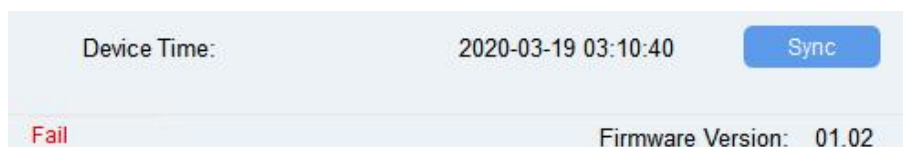

5.2.2 Write Configuration

1. Go to “Settings” page to change parameters as requirements and click “save”.
2. Click “Write” and enter the correct password (default password: 123456).

LoRaWAN > Read Write

Basic
Channel

Device EUI

Verify Password
✕

Password:

Please put the NFC antenna close to the NFC reader.

Regular Report Confirmed

ADR Mode

Save

3. Press Enter key to write and attach the device close to NFC reader until “Write” button disappear. The device will automatically re-join the network if LoRaWAN parameters are changed.

Note: Keep the two devices close and don’t move them in order that you can get the best connectivity as possible when writing data via NFC. Bad connection can be caused by long distance, wrong location, or rapid movement.

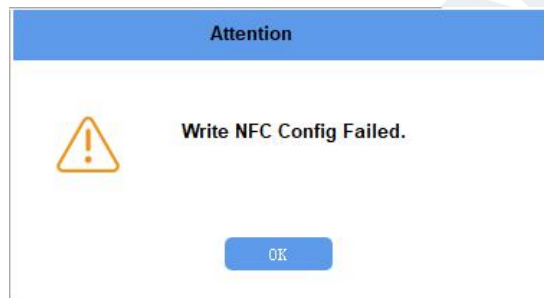

5.2.3 Upgrade

5.2.3.1 Upgrade Locally

1. Download firmware to your computer.
2. Go to “Maintenance -> Upgrade” in Toolbox.
3. Click “Browse” and select the firmware from computer.
4. Click “Upgrade” and enter password of the device.
5. Press Enter key to start upgrade. Device will check if the firmware is correct. If it is correct, firmware will be imported to the device to upgrade.

Note: Keep the two devices close and don’t move them in order that you can get the best connectivity as possible when upgrading. Failing to upgrade can be caused by long distance, wrong location, or rapid movement.

Upgrade >

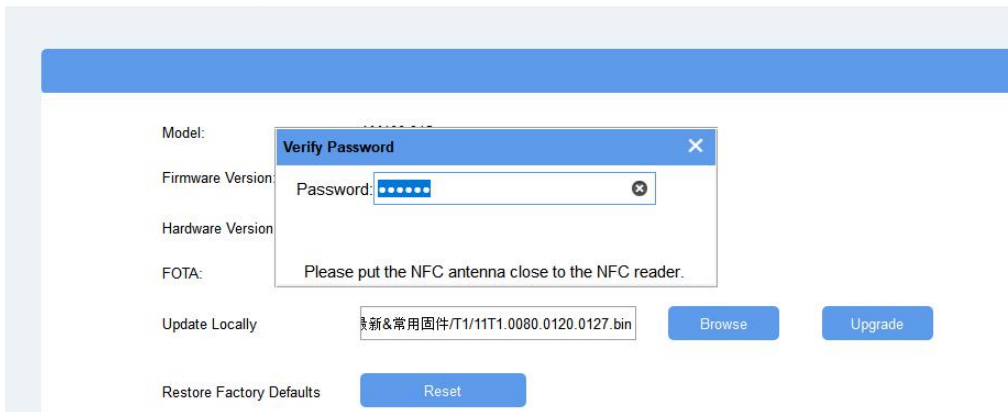

The screenshot shows the Upgrade interface with a 'Verify Password' dialog box open. The dialog box has a title bar 'Verify Password' and a close button. It contains a 'Password:' field with a masked password and a confirmation field. Below the fields, it says 'Please put the NFC antenna close to the NFC reader.' The background interface shows fields for Model, Firmware Version, Hardware Version, and FOTA. There is an 'Update Locally' field with a file path and 'Browse' and 'Upgrade' buttons. A 'Restore Factory Defaults' button with 'Reset' text is also visible.

5.2.3.2 FOTA

1. Make sure your computer can access the Internet.
2. Click “Check for Updates” to search for the latest firmware via computer Internet and upgrade.

Note: Keep the two devices close and don’t move them in order that you can get the best connectivity as possible when upgrading. Failing to upgrade can be caused by long distance, wrong location, or rapid movement.

Upgrade >

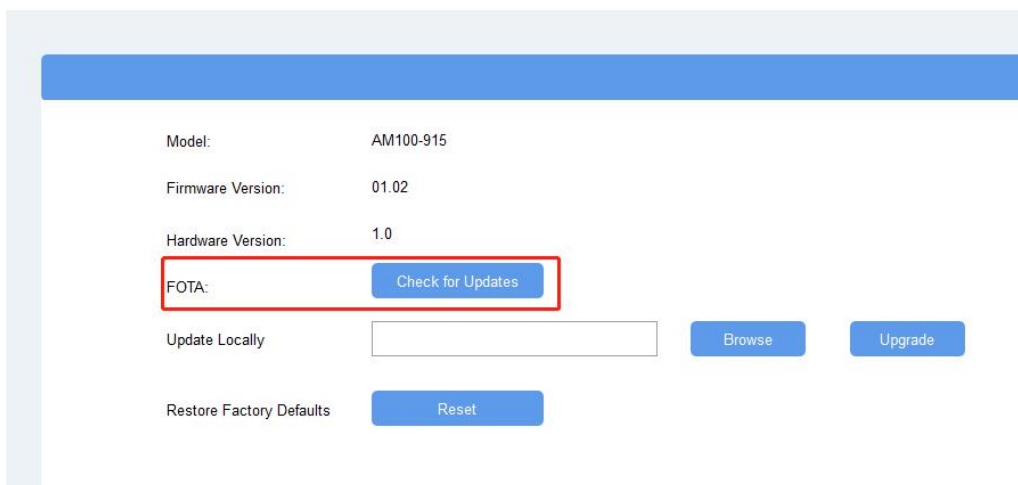

The screenshot shows the Upgrade interface with the 'Check for Updates' button highlighted by a red box. The interface displays the following information: Model: AM100-915, Firmware Version: 01.02, Hardware Version: 1.0. The FOTA section has a 'Check for Updates' button. Below this are 'Update Locally' and 'Browse' buttons, and a 'Restore Factory Defaults' button with 'Reset' text.

6.2.4 Template and Reset

6.2.4.1 Template Configuration

1. Go to “Maintenance -> Template and Reset” in Toolbox.
2. Click “Export” to save the current settings as a template.



Template	<input type="button" value="Export"/>
Config File	<input type="text"/> <input type="button" value="Browse"/> <input type="button" value="Import"/>
Restore Factory Defaults	<input type="button" value="Reset"/>

3. Click "Browse" to select the correct template from computer.
4. Click "Import" to import the template to the device.

6.2.4.2 Reset

Click the "Reset" to reset the setting to factory default.

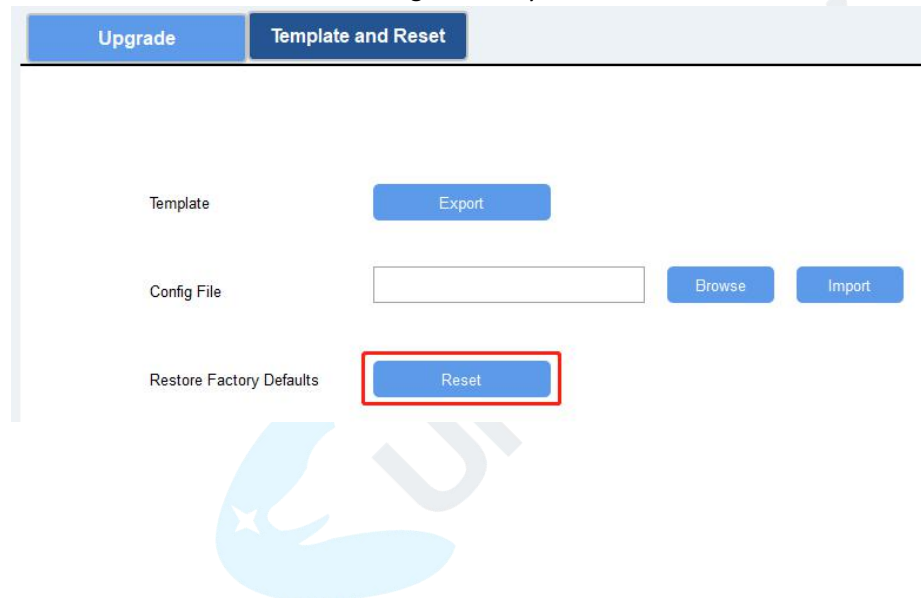

Template	<input type="button" value="Export"/>
Config File	<input type="text"/> <input type="button" value="Browse"/> <input type="button" value="Import"/>
Restore Factory Defaults	<input type="button" value="Reset"/>

6.Sensor Parameters (for App and PC)

6.1 LoRa WAN Settings

6.1.1 Basic Settings-OTAA

Location:

Ursalink ToolBox(PC): LoRaWAN Settings → Basic

Ursalink ToolBox(APP): Device → Settings → LoRaWAN Settings

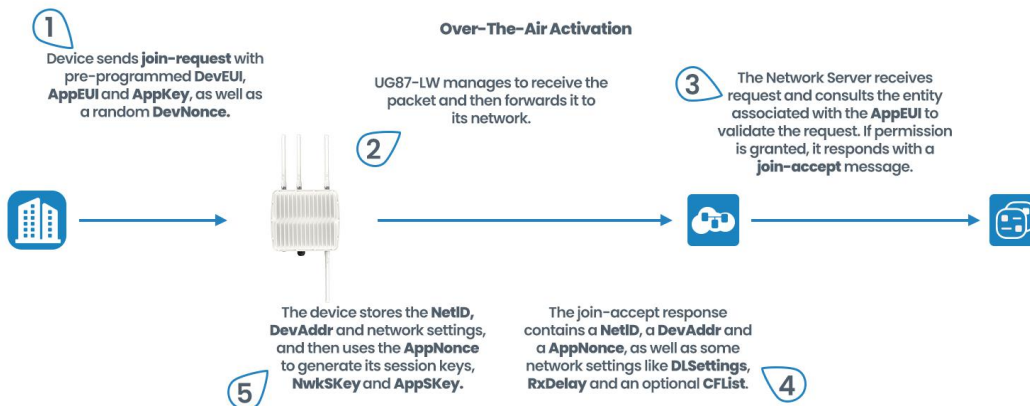

Basic Settings-OTAA		
Item	Description	Default
App EUI	Enter the application EUI.The Network Server receives request and consults the entity associated with the APP EUI to validate the request.If permission is granted, it responds with a join-accept message.	24e124c000 2a0001
Join Type	Select from: "OTAA" and "ABP". OTAA:Over-the-Air Activation. For over-the-air activation, end-devices must follow a join procedure prior to participating in data exchanges with the network server. An end-device has to go through a new join procedure every time it loses the session context information. ABP: Activation by Personalization. Under certain circumstances, end-devices can be activated by personalization. Activation by personalization directly ties an end-device to a specific network by-passing the join request - join accept procedure.	OTAA
Application Key	Enter the application key. Whenever an end-device joins a network via over-the-air activation, the application key is used to derive the Application Session key.	5572404c69 6e6b4c6f526 1323031382 3

Confirmed Mode	<p>After sending the attribute/data/battery packets to the network server, the device will resend these packets if it does not receive ACK bit from the Network Server.</p> <p>Note: If the device doesn't receive ACK for a long time, the device will resend confirmed packets 3 times at most. However, the device will resend attribute package all the time.</p>	Disabled
ADR	<p>ADR : Adaptive Data Rate.</p> <p>Enabled: The Network Server will adjust the datarate by MAC command.</p> <p>Disabled: Whatever how the signal quality is, the Network Server will not adjust the datarate of the device.</p>	Enabled

6.1.2 Basic Settings-ABP

Location:

Ursalink ToolBox(PC): LoRaWAN Settings → Basic

Ursalink ToolBox(APP): Device → Settings → LoRaWAN Setting

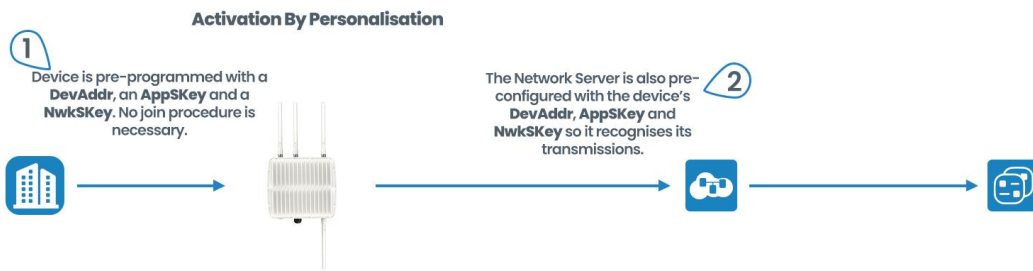

Basic Settings-ABP		
Item	Description	Default
App EUI	Enter the application EUI.The Network Server receives request and consults the entity associated with the APP EUI to validate the request.If permission is granted, it responds with a join-accept message.	24e124c0002 a0001
Join Type	<p>Select from: "OTAA" and "ABP".</p> <p>OTAA:Over-the-Air Activation.</p> <p>For over-the-air activation, end-devices must follow a join procedure prior to participating in data exchanges with the network server. An end-device has to go through a new join procedure every time it has lost the session context information.</p> <p>ABP: Activation by Personalization.</p> <p>Under certain circumstances, end-devices can be</p>	OTAA

	activated by personalization. Activation by personalization directly ties an end-device to a specific network by-passing the join request - join accept procedure.	
Device Address	Enter the device address. The device address identifies the end-device within the current network.	The 5 th to 12 th digits number of SN
Network Session Key	Enter the network session key of the device. The network session key specific for the end-device. It is used by the end-device to calculate the MIC or part of the MIC (message integrity code) of all uplink data messages to ensure data integrity.	5572404c696 e6b4c6f5261 3230313823
Application Session Key	Enter the application session key of the device. The AppKey is an application session key specific for the end-device. It is used by both the application server and the end-device to encrypt and decrypt the payload field of application-specific data messages.	5572404c696 e6b4c6f5261 3230313823
Confirmed Mode	<p>After sending the attribute/data/battery packets to the network server, the device will resend these packets if it does not receive ACK bit from the Network Server.</p> <p>Note: If the device doesn't receive ACK for a long time, the device will resend confirmed packets 3 times at most. However, the device will resend attribute package all the time.</p>	Disabled
ADR	<p>ADR : Adaptive Data Rate.</p> <p>Enabled: The Network Server will adjust the datarate by MAC command.</p> <p>Disabled: Whatever how the signal quality is, the Network Server will not adjust the datarate of the device.</p>	Enabled

6.1.3 Channel Settings

Location:

Ursalink ToolBox(PC): LoRaWAN Settings → Channel

Ursalink ToolBox(APP): Device → Settings → LoRaWAN Settings

Note: Make sure the LoRa channel configuration of EM500-UDL matches the LoRaWAN gateway.

LoRa frequency configuration is as follows if the sensor LoRa frequency is one of EU433/EU868/RU864/IN865/AS923/KR920:

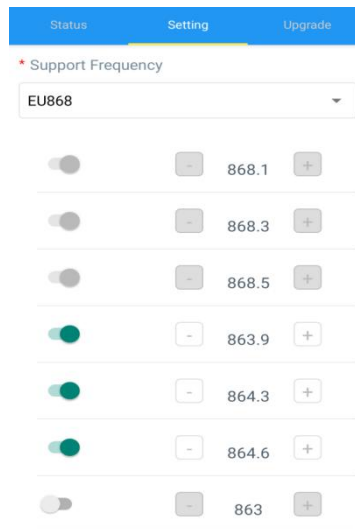

LoRa frequency configuration is as follows if the sensor LoRa frequency is one of CN470/US915/AU915:

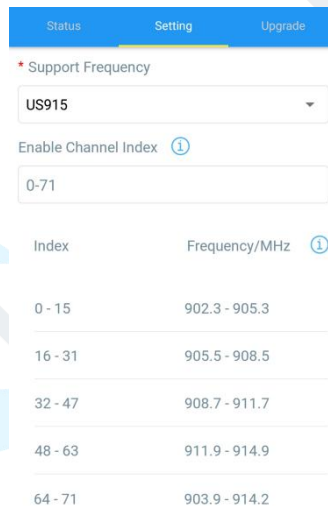

Index	Frequency/MHz
0 - 15	902.3 - 905.3
16 - 31	905.5 - 908.5
32 - 47	908.7 - 911.7
48 - 63	911.9 - 914.9
64 - 71	903.9 - 914.2

Enter the index of the channel to be enabled in the input box, separated by commas.

Example:

1, 40: Enabling Channel 1 and Channel 40

1-40: Enabling Channel 1 to Channel 40

1-40, 60: Enabling Channel 1 to Channel 40 and Channel 60

All: Enabling all channels

Null: Indicates that all channels are disabled

Note:

For US915:

64 channels numbered 0 to 63 utilize LoRa 125 kHz BW starting at 902.3 MHz and incrementing linearly by 0.2 MHz to 914.9.

8 channels numbered 64 to 71 utilize LoRa 500 kHz BW starting at 903.0 MHz and incrementing linearly by 1.6 MHz to 914.2.

For AU915:

64 channels numbered 0 to 63 utilize LoRa 125 kHz BW starting at 915.2 MHz and incrementing linearly by 0.2 MHz to 927.8.

8 channels numbered 64 to 71 utilizing LoRa 500 kHz BW starting at 915.9 MHz and incrementing linearly by 1.6 MHz to 927.1.

For CN470:

80 channels numbered 0 to 79 utilize LoRa 125 kHz BW starting at 470.3 MHz and incrementing linearly by 0.2 MHz to 486.1.

16 channels numbered 80 to 95 utilize LoRa 125 kHz BW starting at 486.3 MHz and incrementing linearly by 1.6 MHz to 489.3.

6.2 Device Settings

6.2.1 General

Location:

Ursalink ToolBox(PC): Device Settings → General

Ursalink ToolBox(APP): Device → Settings → General Settings

Device General Settings		
Item	Description	Default
Device Type	Show the type of the device.	Null
Reporting Interval	The sensor reports the sampling data at regular intervals. Range: 5-30 (mins)	10
Change Password	Change the password used for changing device status and writing configuration.	Disabled

6.2.2 Data Calibration

Location:

Ursalink ToolBox(PC): Device Settings → Data Calibration Settings

Ursalink ToolBox(APP): Device → Settings → Data Calibration Settings

Note: It is recommended to do the calibration before using the device.

Data Calibration Settings		
Item	Description	Default
Enable	Enable calibration.	Disabled
Current Raw Value	The current value.	Null
Distance/Level Calibration	Enter the calibration value for distance/level. Note: only two decimal is allowed.	Null
Final Value	Adjusted value.	Null
Abnormal Value	Enable abnormal value prevention.	Disabled

Prevention		
Set Value	<p>Setting value=$A - B / C * 100\%$. (A=current measured value; B=previous measured value; C=maximum range)</p> <p>If the current measured value exceeds the set value after calculation by the previous formula, it is abnormal and device will measure again.</p>	Null

6.2.3 Threshold

Location:

Ursalink ToolBox(PC): Device Settings → Threshold Settings

Ursalink ToolBox(APP): Device → Settings → Threshold Settings

Threshold Settings		
Item	Description	Default
Distance/Level	Enable: The device will send the latest distance/level value to network server if it goes above/below distance/level thresholds.	Disabled
Over	Enter the maximum distance/level threshold.	Null
Below	Enter the minimum distance/level threshold.	Null

Example: Set the "Lockout Time" for 10min, "Duration" for 5min.

The device will report the detected value immediately when the value reaches the threshold and last for 5mins. After that, the device will check the detected value every 10 mins, and report the value again if it reaches the threshold and last for 5mins.

7.Sensor Management via Ursalink Cloud

Ursalink cloud is a comprehensive platform that provides multiple services including device remote management and data visualization with the easiest operation procedures.

7.1 Ursalink Cloud Registration

Register and log in Ursalink Cloud.

Ursalink Cloud URL: <https://cloud.ursalink.com/login.html>

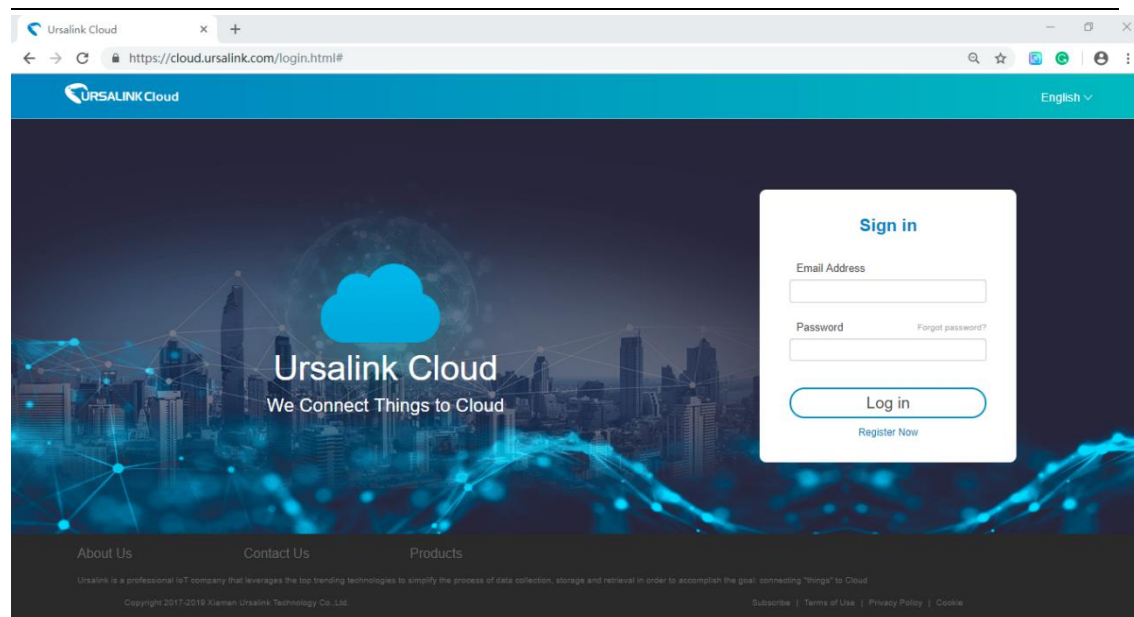



7.2 Add a Ursalink LoRaWAN Gateway

1. Enable “Ursalink” type network server and “Ursalink Cloud” mode in gateway web GUI.

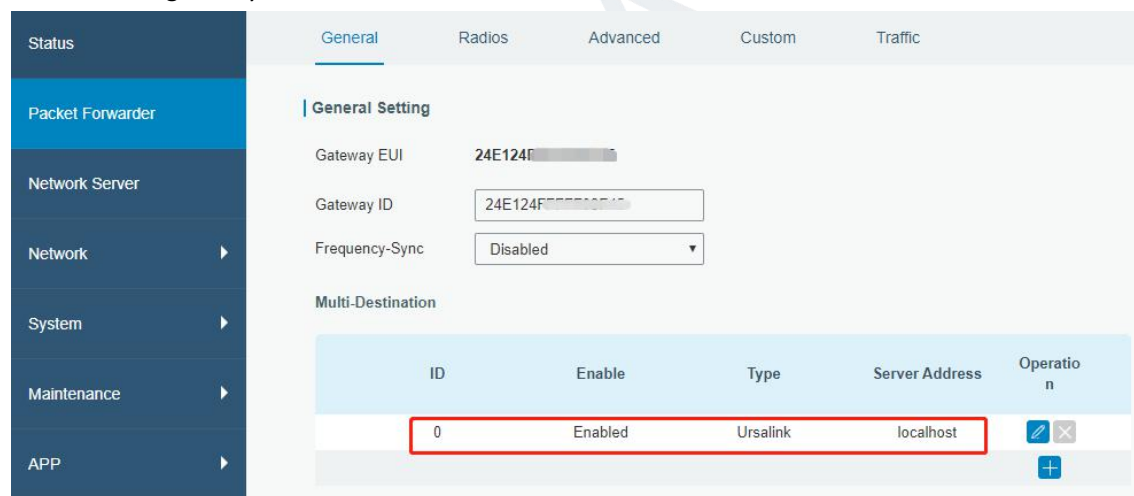
Note: Ensure gateway has accessed the Internet.



ID	Enable	Type	Server Address	Operation
0	Enabled	Ursalink	localhost	 
				

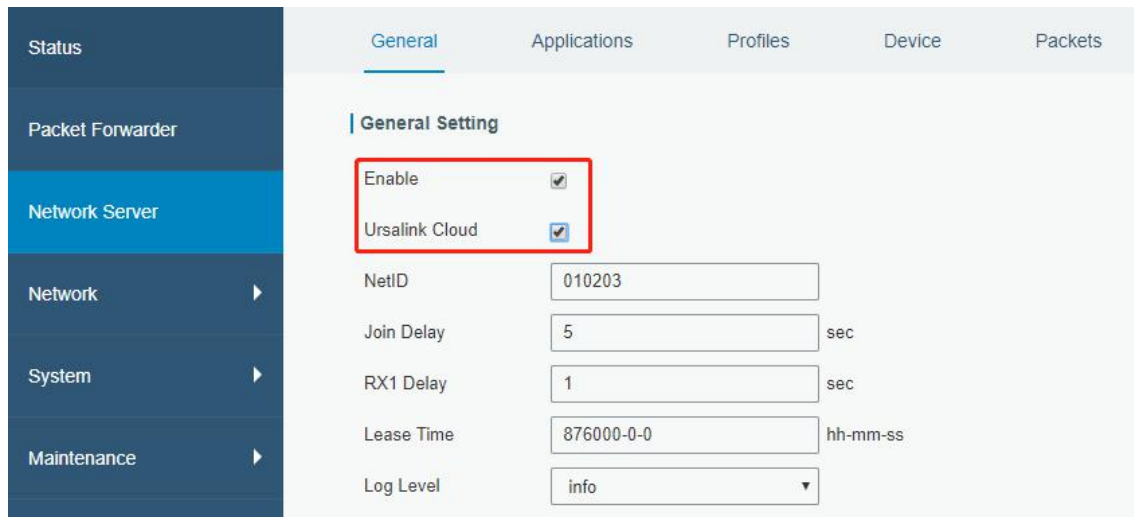

The screenshot shows the 'General Setting' page in the URSALINK web interface. The 'Enable' and 'Ursalink Cloud' checkboxes are checked and highlighted with a red box. Other settings include NetID (010203), Join Delay (5 sec), RX1 Delay (1 sec), Lease Time (876000-0-0 hh-mm-ss), and Log Level (info).

2. Go to “My Devices->Gateway” of Ursalink Cloud and click “Add” to add gateway to Ursalink Cloud via SN.

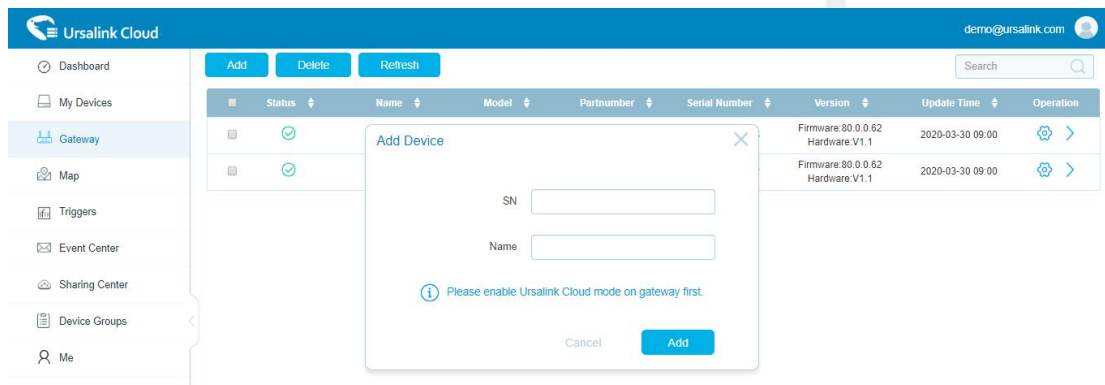



The screenshot shows the 'Add Device' dialog box in the URSALINK web interface. The dialog box has fields for SN and Name, and a message: "Please enable Ursalink Cloud mode on gateway first." The background shows a table of gateways with columns for Status, Name, Model, Partnumber, Serial Number, Version, Update Time, and Operation.

3. Check if gateway is online in Ursalink Cloud.



The screenshot shows the 'Gateway' page in the URSALINK web interface. The table shows two gateways with status 'Online'.

Status	Name	Model	Partnumber	Serial Number	Version	Update Time	Operation
Online	231	UG85-L00E-EU888	L00E-EU888	6217500000000	Firmware:80.0.0.62 Hardware:V1.1	2020-03-30 09:00	 
Online	621793195782	UG85-L01CE-CN470	L01CE-CN470	6217500000000	Firmware:80.0.0.62 Hardware:V1.1	2020-03-30 09:00	 

7.3 Add EM500-UDL to Cloud

1. Go to “Device->My Devices” and click “Add Device”. Fill in the SN of EM500-UDL and select associated gateway.

Add Device

SN

Name

Associated Gateway

Device EUI

Application Key

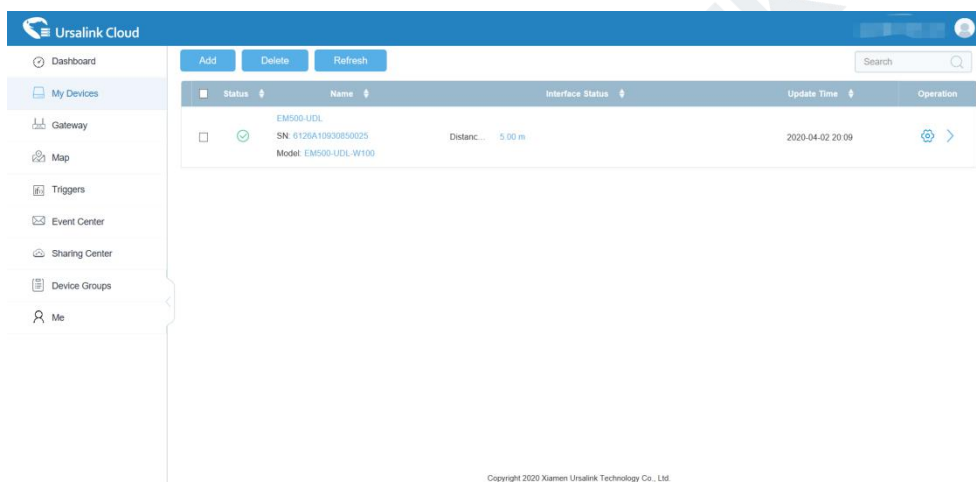

2. After EM500-UDL is connected to Ursalink Cloud, Click  or “History Data” to check the data on Ursalink cloud.



Ursalink Cloud

Dashboard My Devices Gateway Map Triggers Event Center Sharing Center Device Groups Me

Add Delete Refresh

Status	Name	Interface Status	Update Time	Operation
<input type="checkbox"/>	EM500-UDL SN: 6126A10930850025 Model: EM500-UDL-W100	Distanc... 5.00 m	2020-04-02 20:09	 

Copyright 2020 Xiamen Ursalink Technology Co., Ltd.

3. Go to “Dashboard” page to add dashboard.

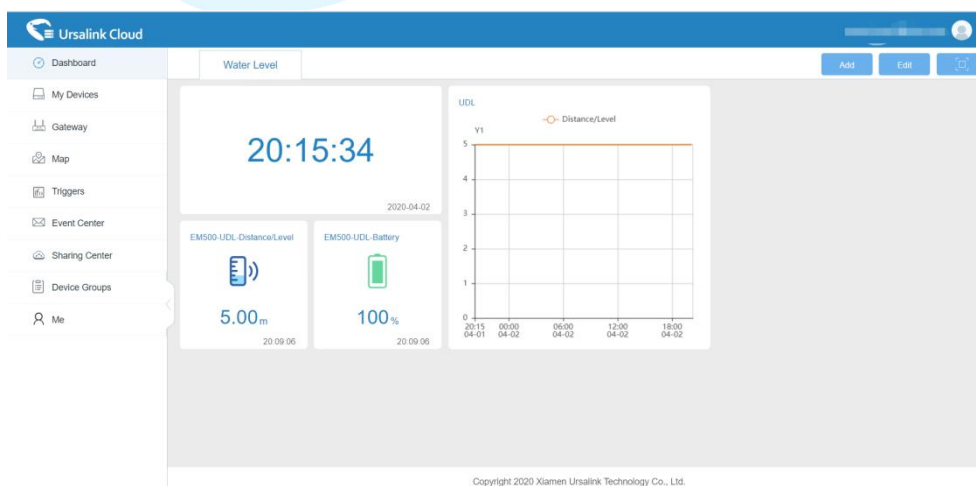

Ursalink Cloud

Dashboard My Devices Gateway Map Triggers Event Center Sharing Center Device Groups Me

Water Level Add Edit

20:15:34

2020-04-02

EM500-UDL Distance/Level: 5.00 m

EM500-UDL Battery: 100%

UDL Distance/Level

Y1

20:15 04-01 00:00 04-02 06:00 04-02 12:00 04-02 18:00 04-02

Copyright 2020 Xiamen Ursalink Technology Co., Ltd.

-END-